



STARFLYER

STARFLYER AIRBUS A320 : PATTERN



Canon® is a registered trademark of Canon Inc.

© Canon Inc. © P.Model K. Kiyonaga



<http://www.canon.com/c-park/en/>



Completed Model (Total length)	About 520mm (Scale - About 1:72)
(Total width)	About 468mm
Pattern	19 pages (No.of Parts: 296)
Assembly Instruction	20 pages

STARFLYER AIRBUS A320

This model is based on the STARFLYER AIRBUS A320, a passenger aircraft manufactured by Airbus and operated by Star Flyer Inc., and covers the route between Tokyo's Haneda Airport and Kitakyushu.

This beautifully refined black aircraft was designed with the image of "21st century chic". Seat numbers have been reduced to 144 from the standard 170, allowing 12cm extra legroom for each seat. All seats are covered in leather, and equipped with power outlets for laptop computers, and plasma screen personal TV sets.

The AIRBUS A320 features an overall length of 37.57m and is 11.76m high, with a wingspan of 34.10m.

With a maximum take-off weight of 77 tons and an economical cruising speed of 840 km/h, it can cover distances of up to 5,500 km.

This model was designed for Papercraft and may differ from the original in some respects.

*Build the model by carefully reading the Assembly Instructions, in the parts sheet page order.



STARFLYER

STARFLYER AIRBUS A320 : PATTERN



Canon® is a registered trademark of Canon Inc.
© Canon Inc. © P. Model K. Kiyonaga

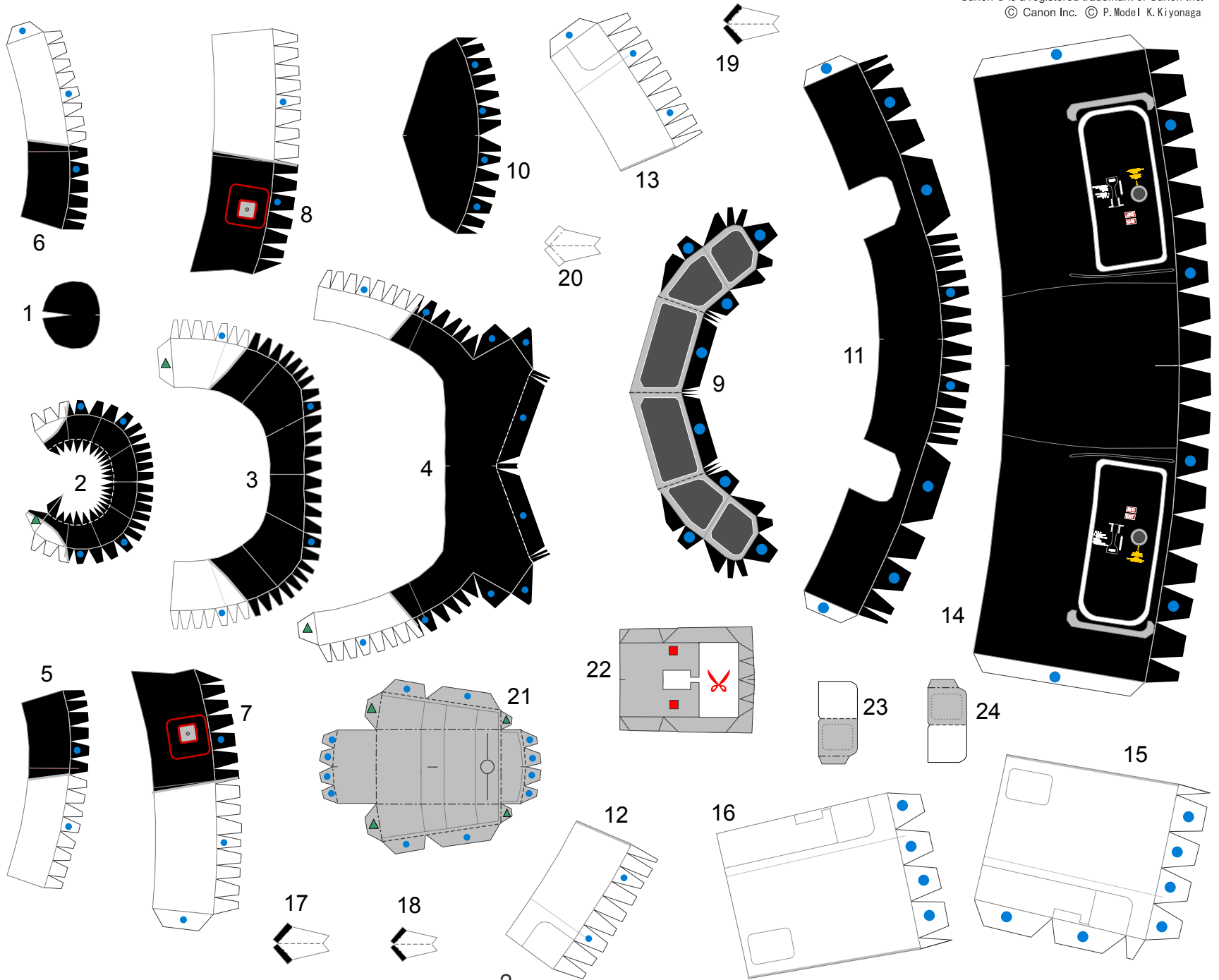



STARFLYER

STARFLYER AIRBUS A320 : PATTERN



Canon® is a registered trademark of Canon Inc.

© Canon Inc. © P. Model K. Kiyonaga

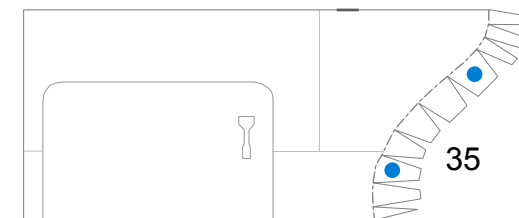
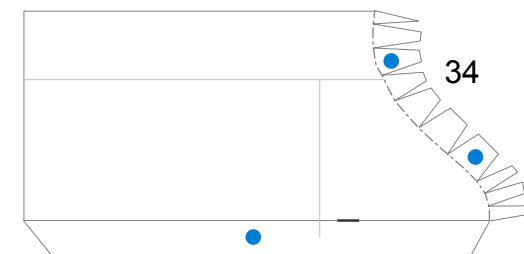
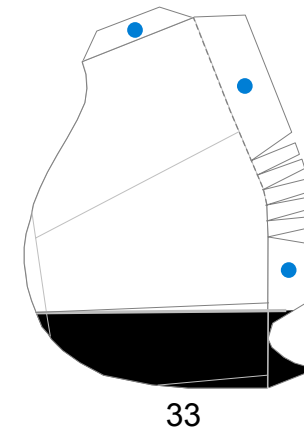
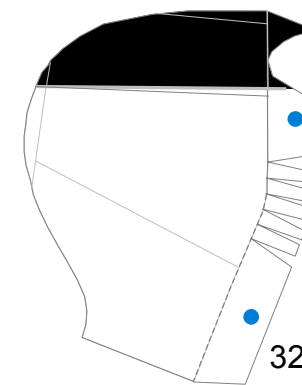
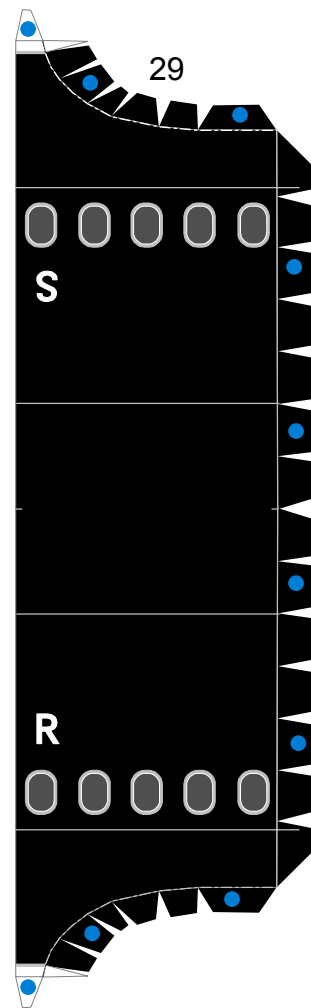
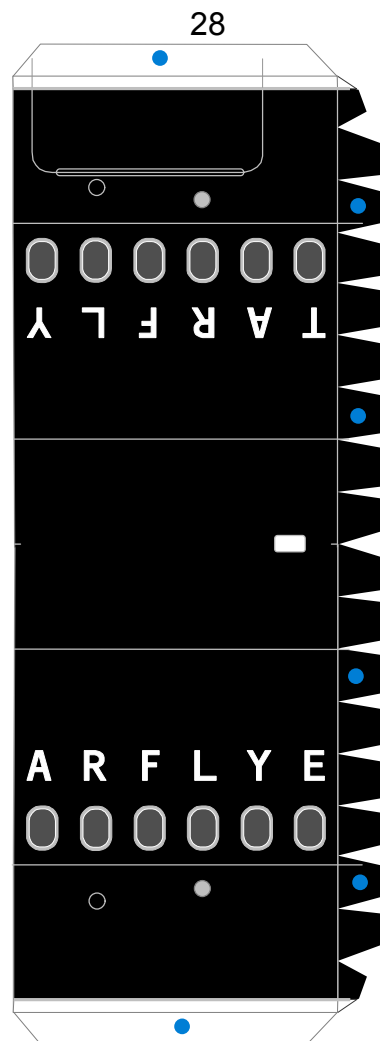
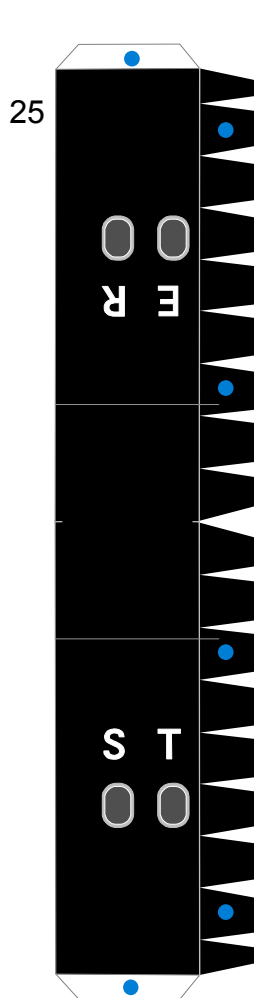
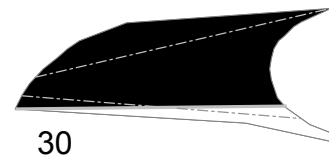
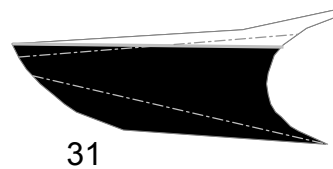
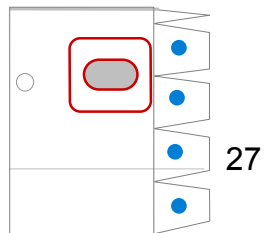
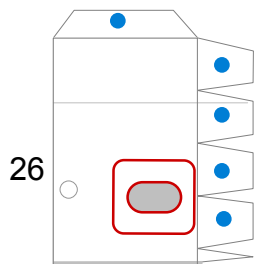



STARFLYER

STARFLYER AIRBUS A320 : PATTERN



Canon® is a registered trademark of Canon Inc.
© Canon Inc. © P. Model K. Kiyonaga

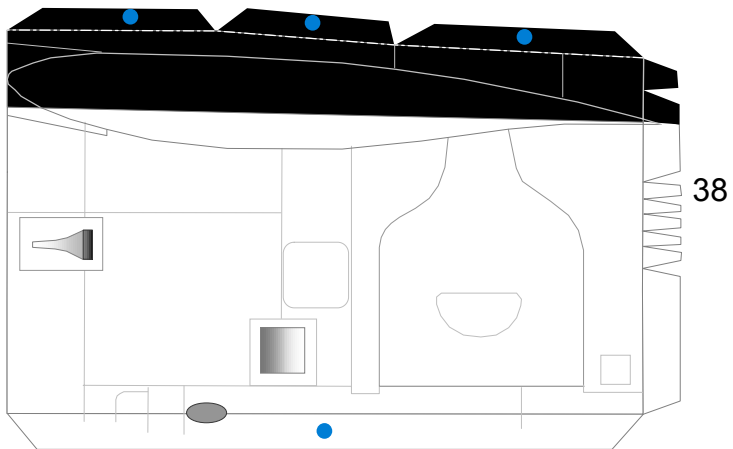
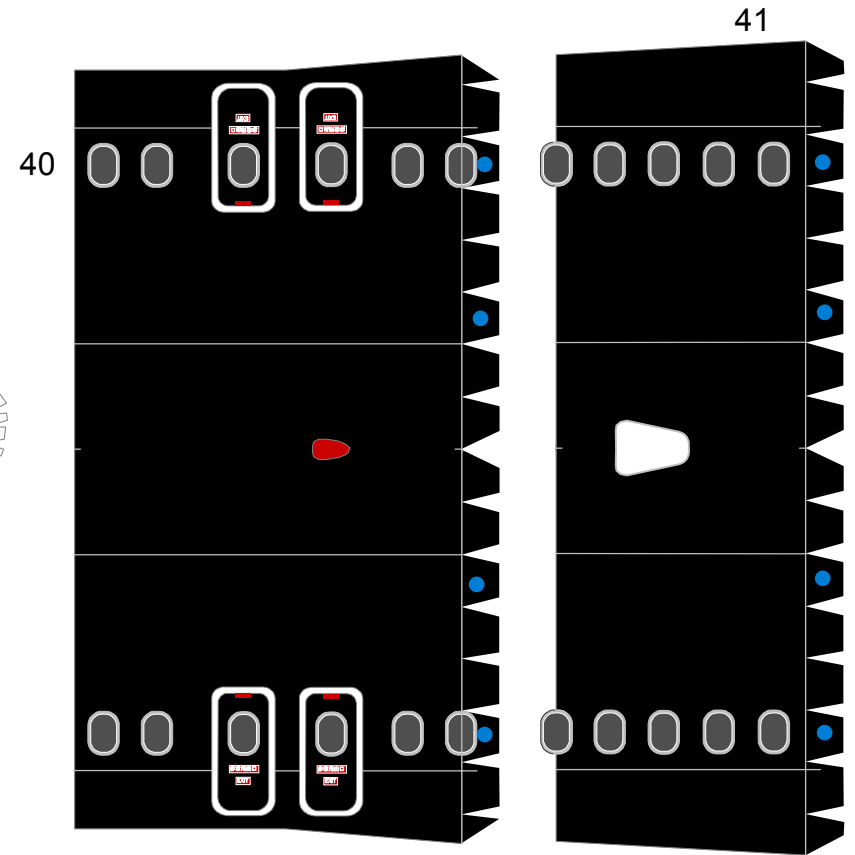
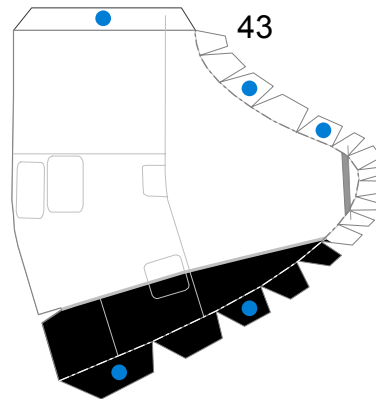
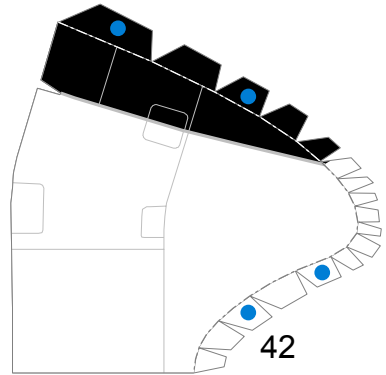
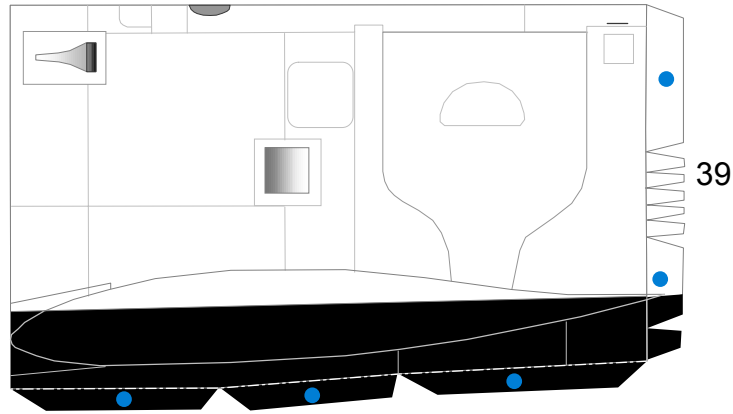



STARFLYER

STARFLYER AIRBUS A320 : PATTERN



Canon® is a registered trademark of Canon Inc.
© Canon Inc. © P. Model K. Kiyonaga

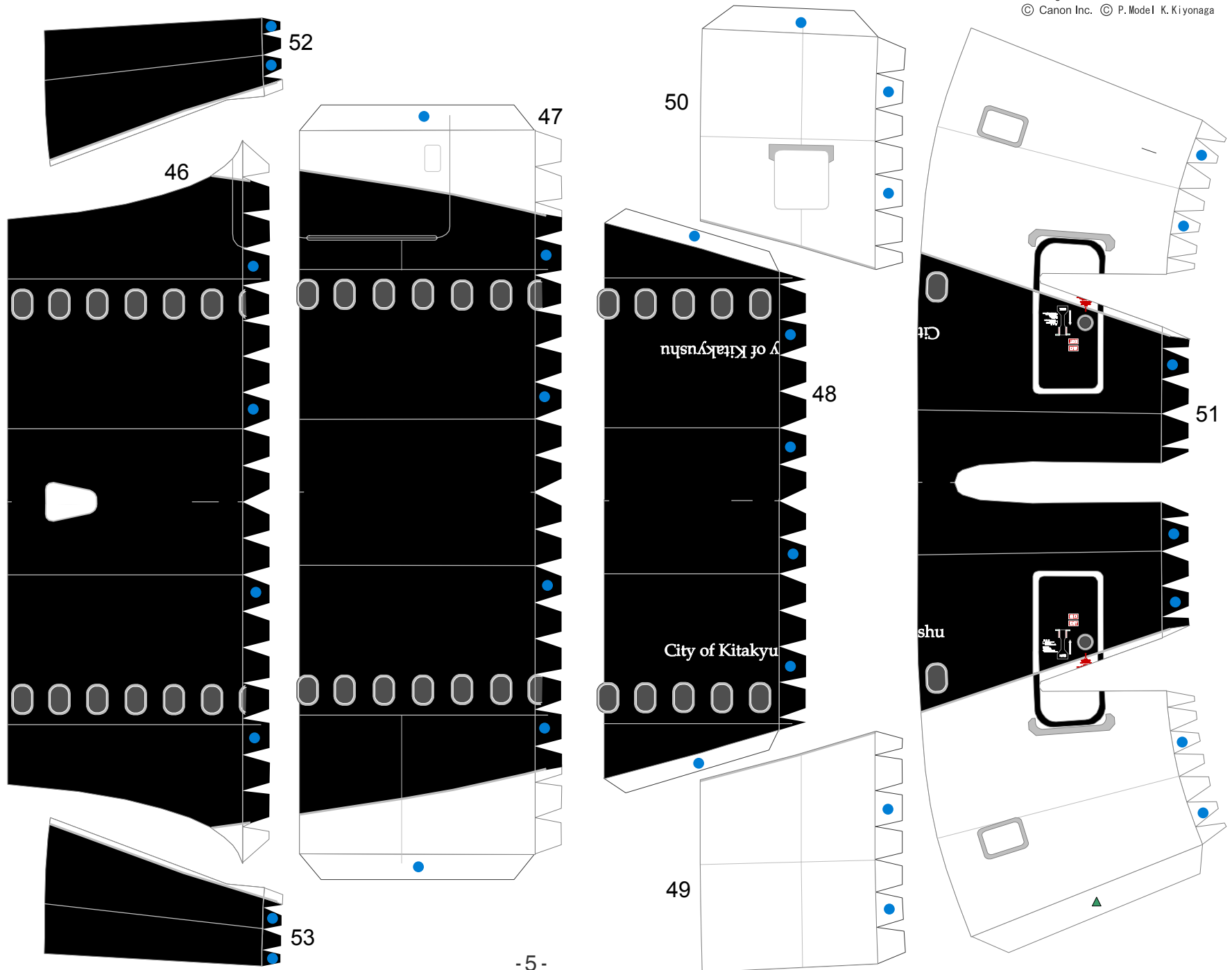



STARFLYER

STARFLYER AIRBUS A320 : PATTERN



Canon® is a registered trademark of Canon Inc.
© Canon Inc. © P. Model K. Kiyonaga

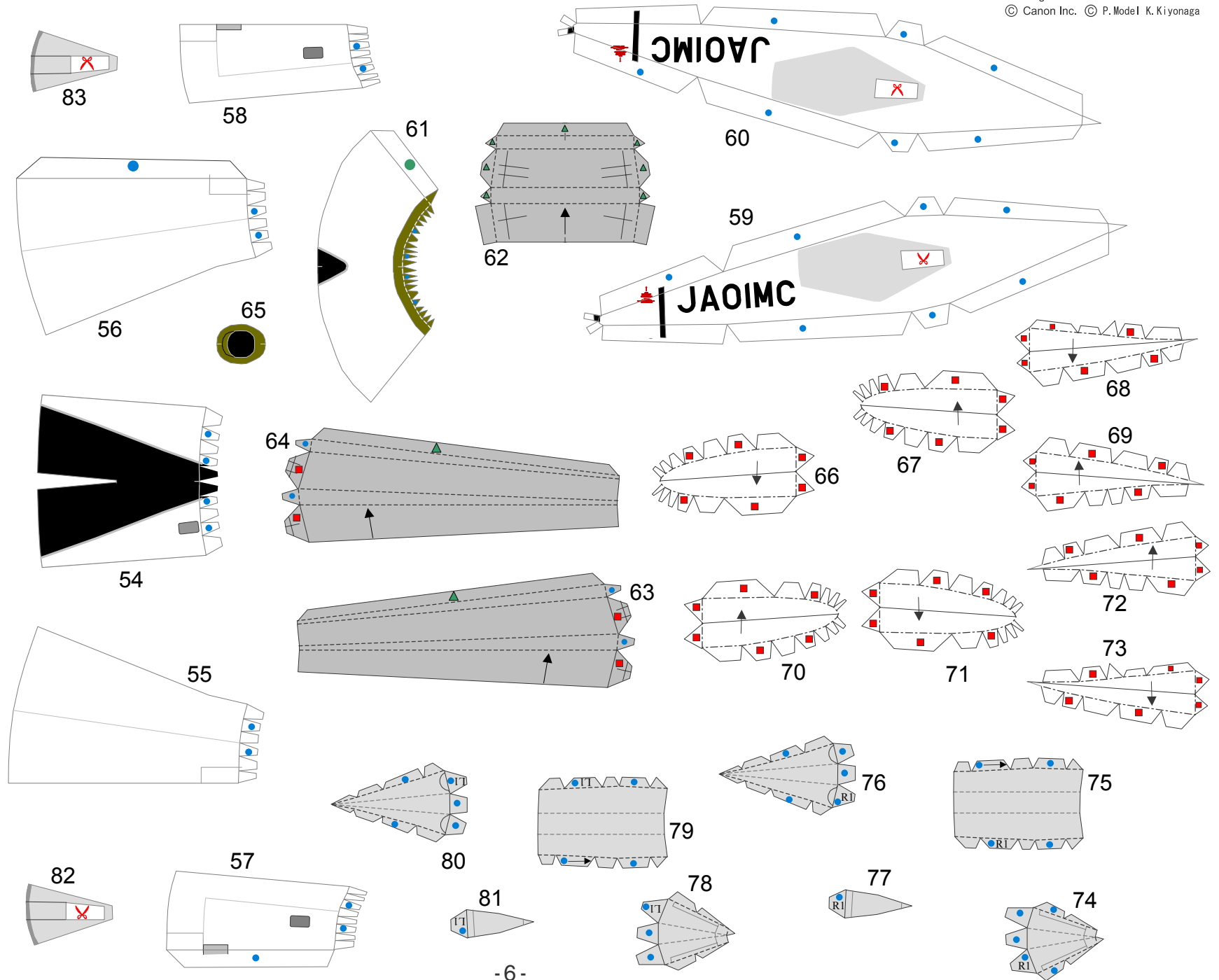



STARFLYER

STARFLYER AIRBUS A320 : PATTERN



Canon® is a registered trademark of Canon Inc.
© Canon Inc. © P. Model K. Kiyonaga

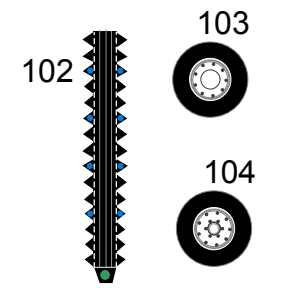
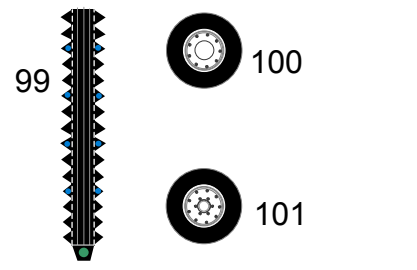
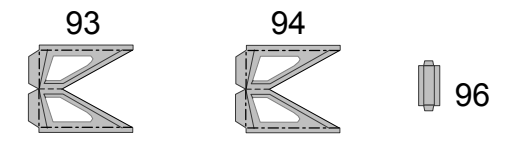
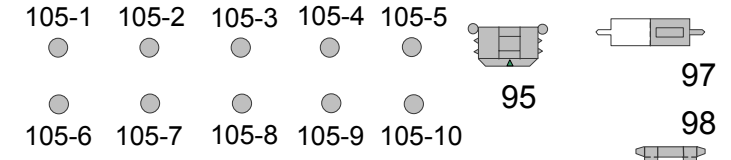
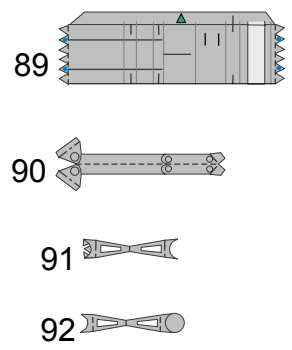
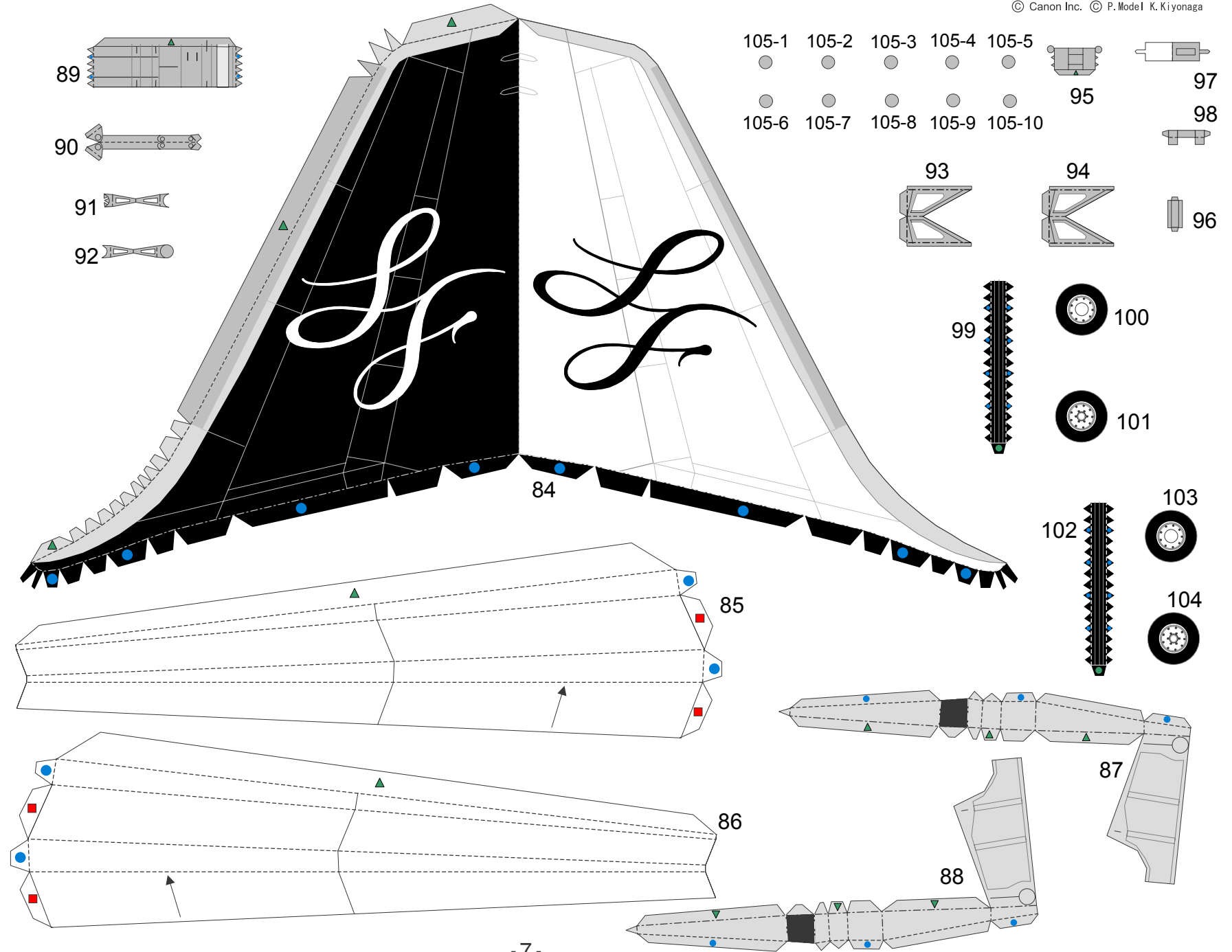



STARFLYER

STARFLYER AIRBUS A320 : PATTERN



Canon® is a registered trademark of Canon Inc.
© Canon Inc. © P. Model K. Kiyonaga

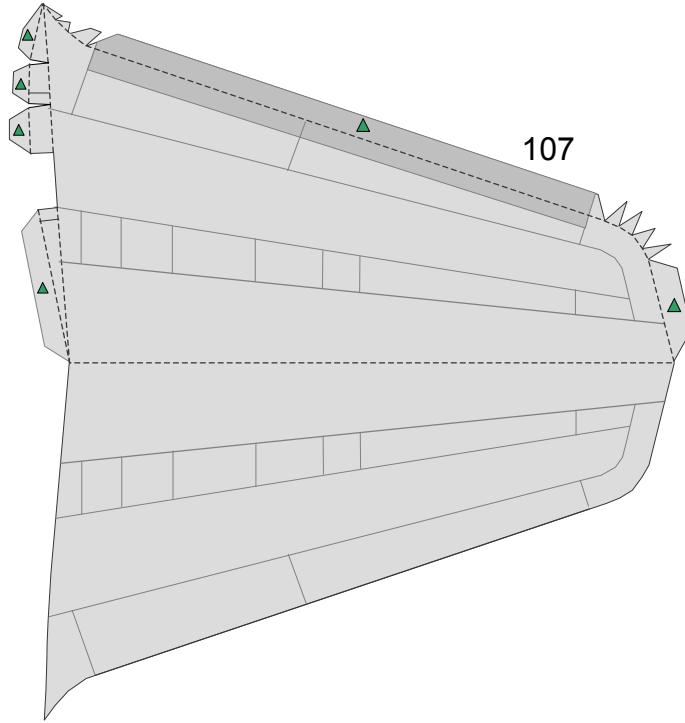

107

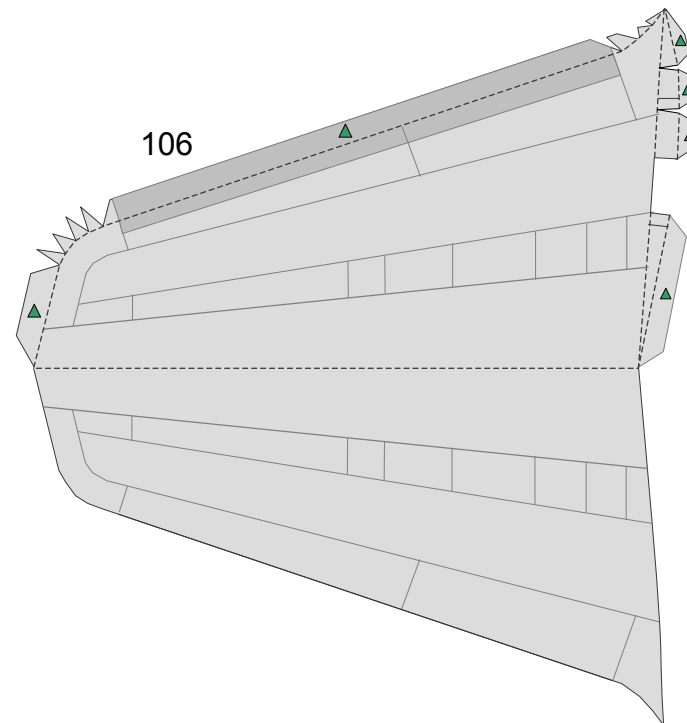

106

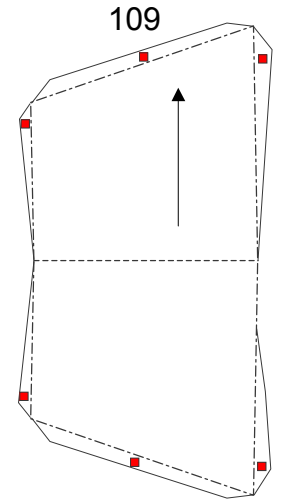

109

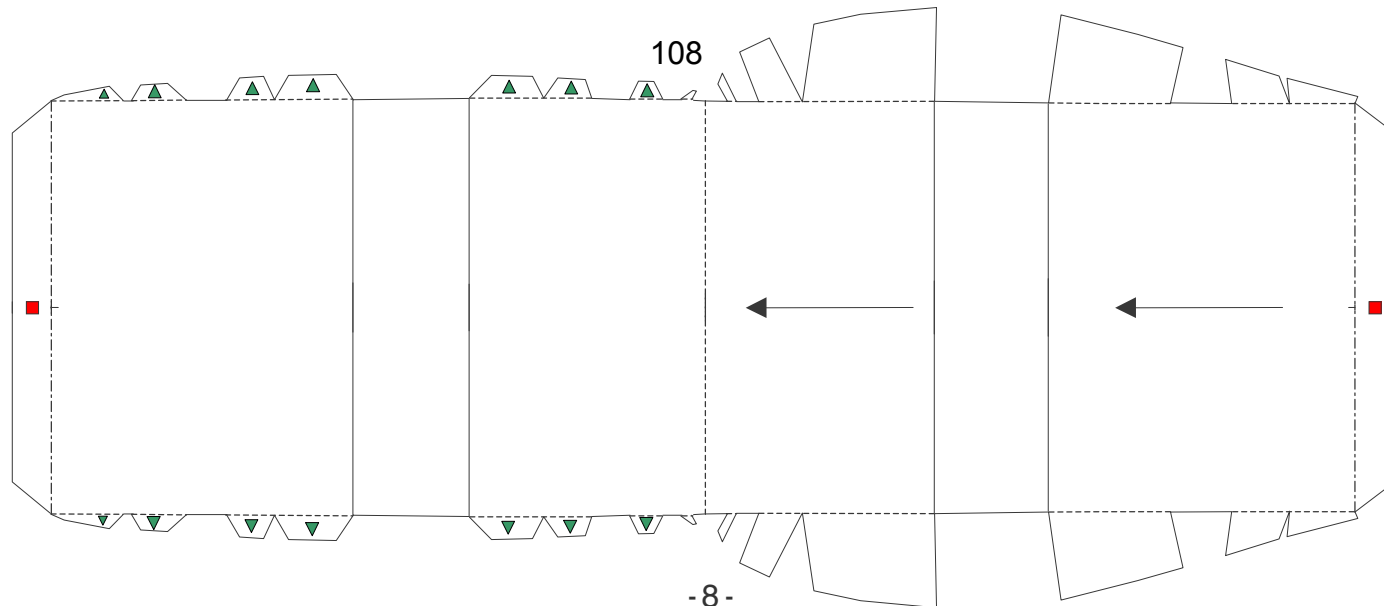

108

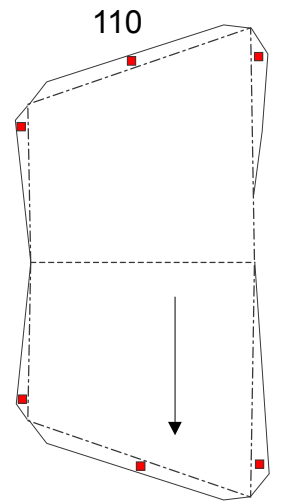

110



STARFLYER

STARFLYER AIRBUS A320 : PATTERN



Canon® is a registered trademark of Canon Inc.
© Canon Inc. © P. Model K. Kiyonaga

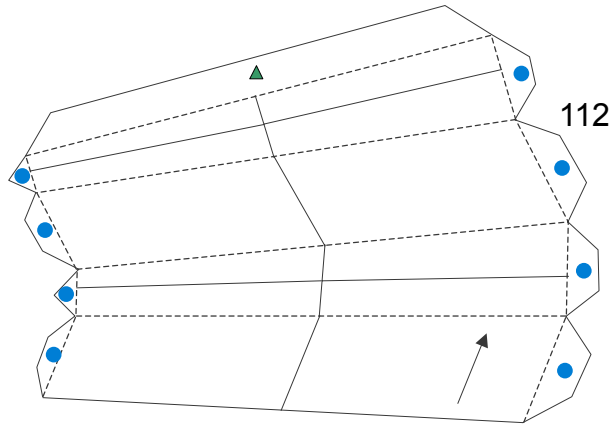

112

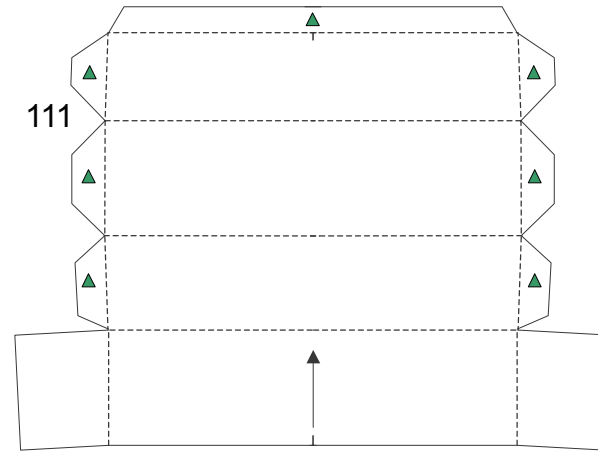

111

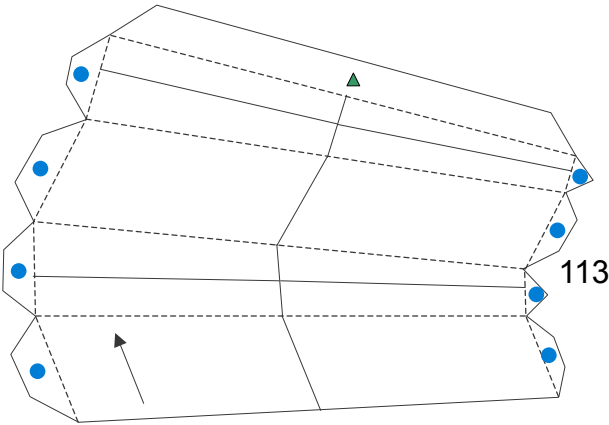

113

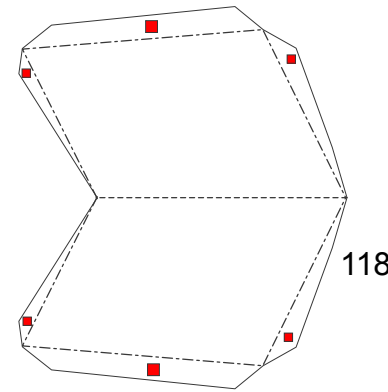

118

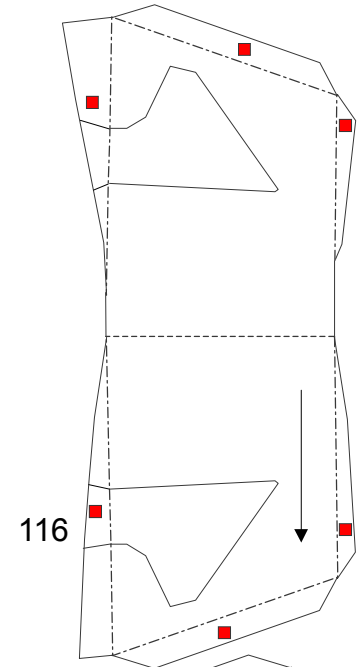

116

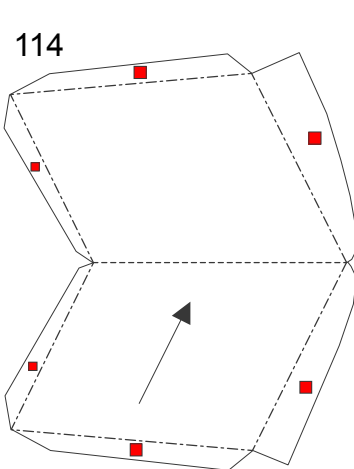

114

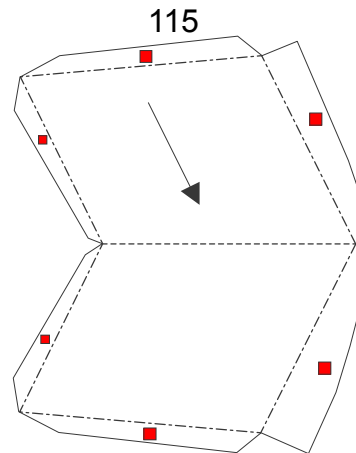

115

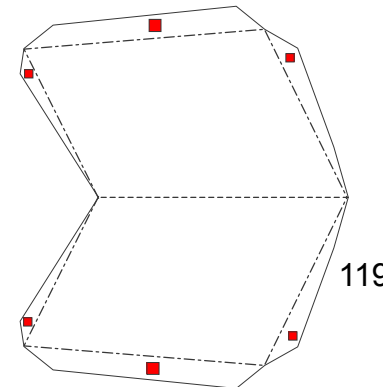

119

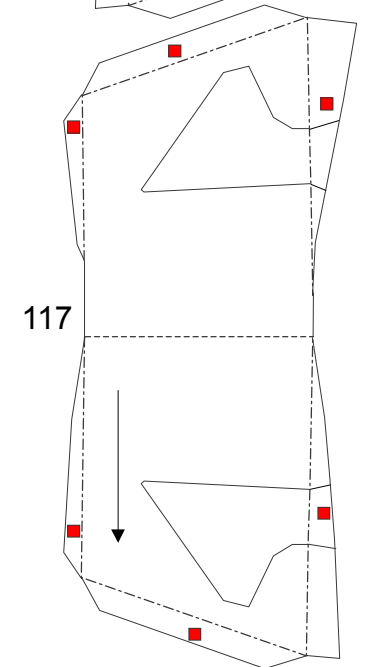

117



STARFLYER

STARFLYER AIRBUS A320 : PATTERN



Canon® is a registered trademark of Canon Inc.
© Canon Inc. © P. Model K. Kiyonaga

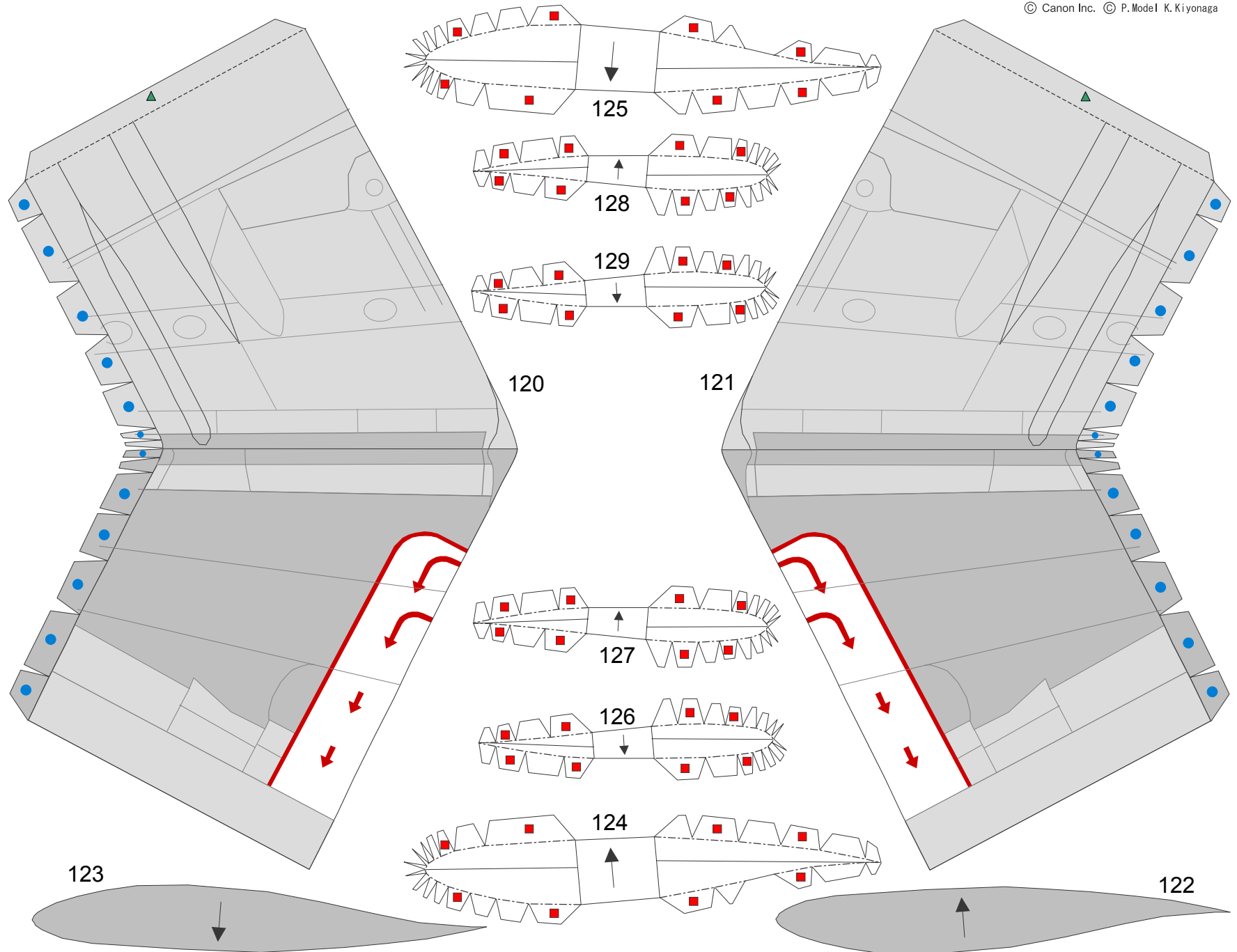



STARFLYER

STARFLYER AIRBUS A320 : PATTERN



Canon® is a registered trademark of Canon Inc.
© Canon Inc. © P. Model K. Kiyonaga

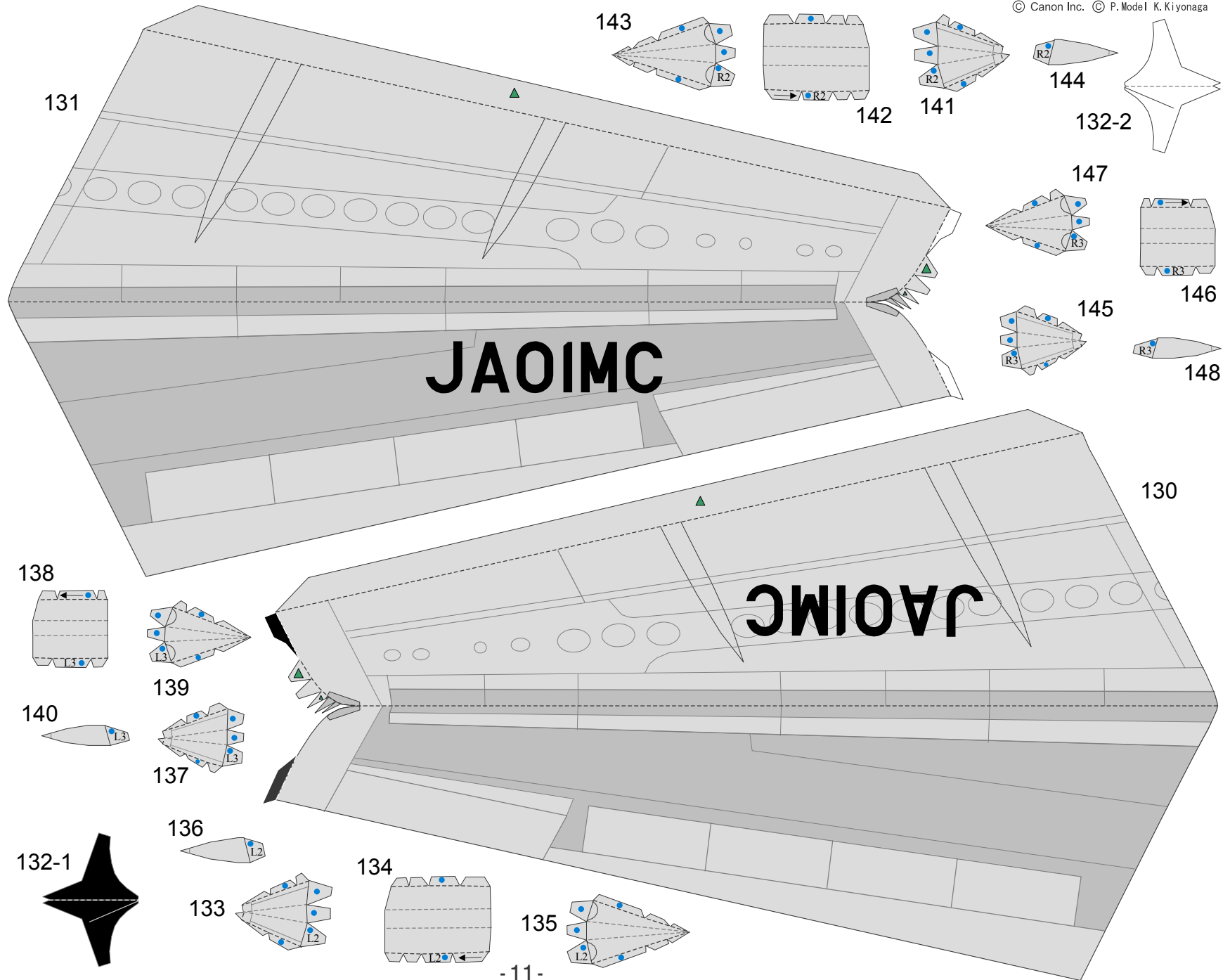



STARFLYER

STARFLYER AIRBUS A320 : PATTERN



Canon® is a registered trademark of Canon Inc.
© Canon Inc. © P. Model K. Kiyonaga

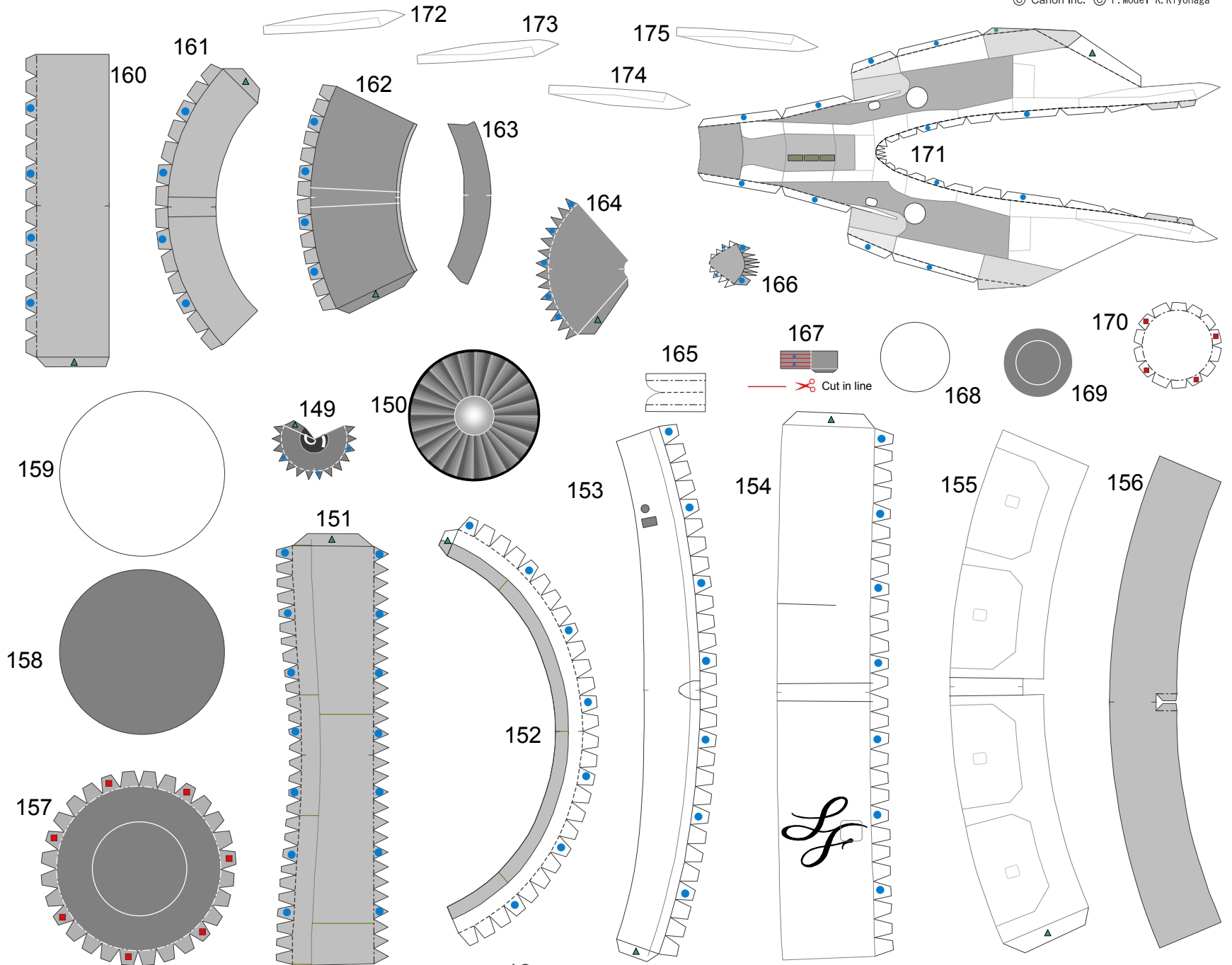



STARFLYER

STARFLYER AIRBUS A320 : PATTERN



Canon® is a registered trademark of Canon Inc.
© Canon Inc. © P. Model K. Kiyonaga

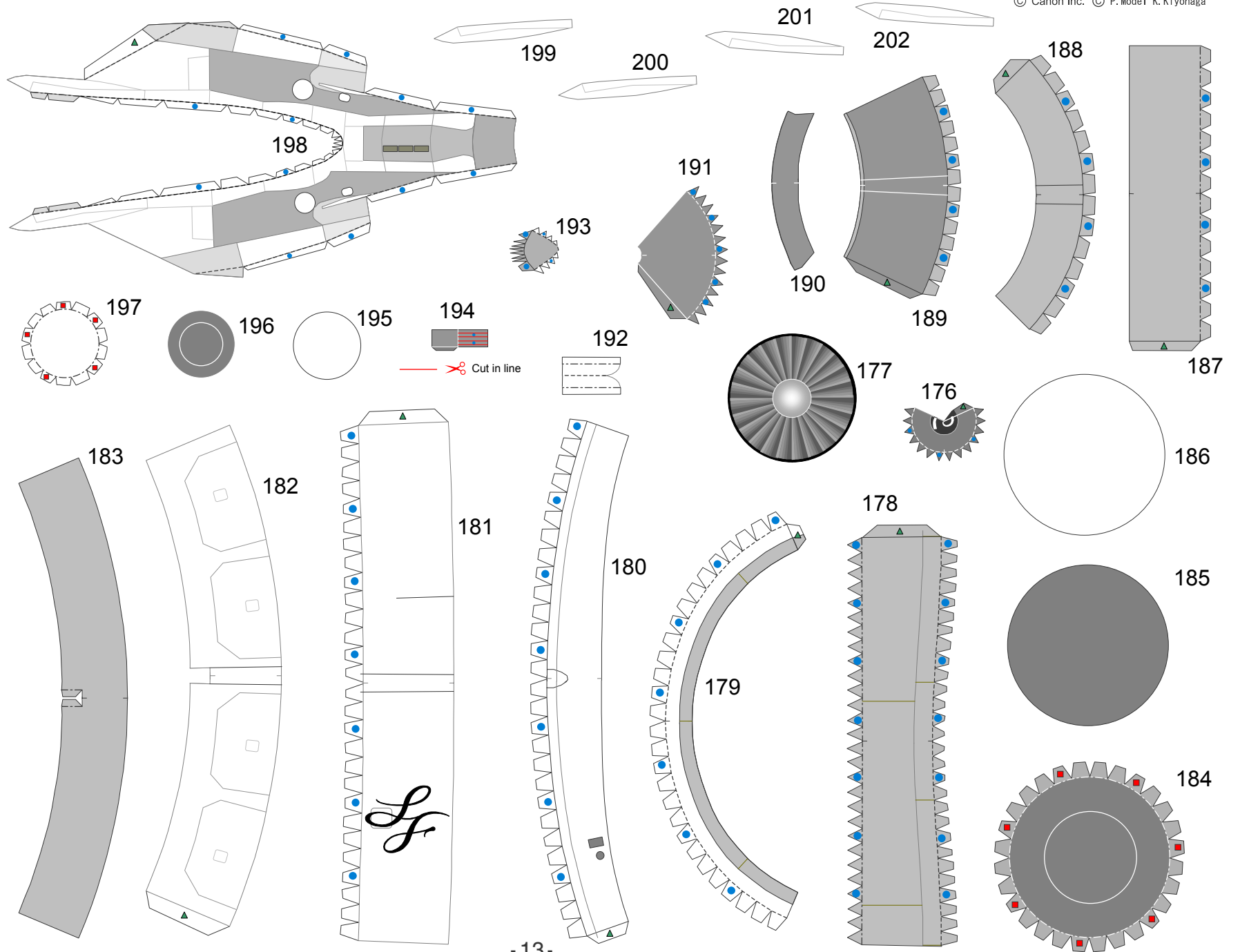



STARFLYER

STARFLYER AIRBUS A320 : PATTERN



Canon® is a registered trademark of Canon Inc.
© Canon Inc. © P. Model K. Kiyonaga

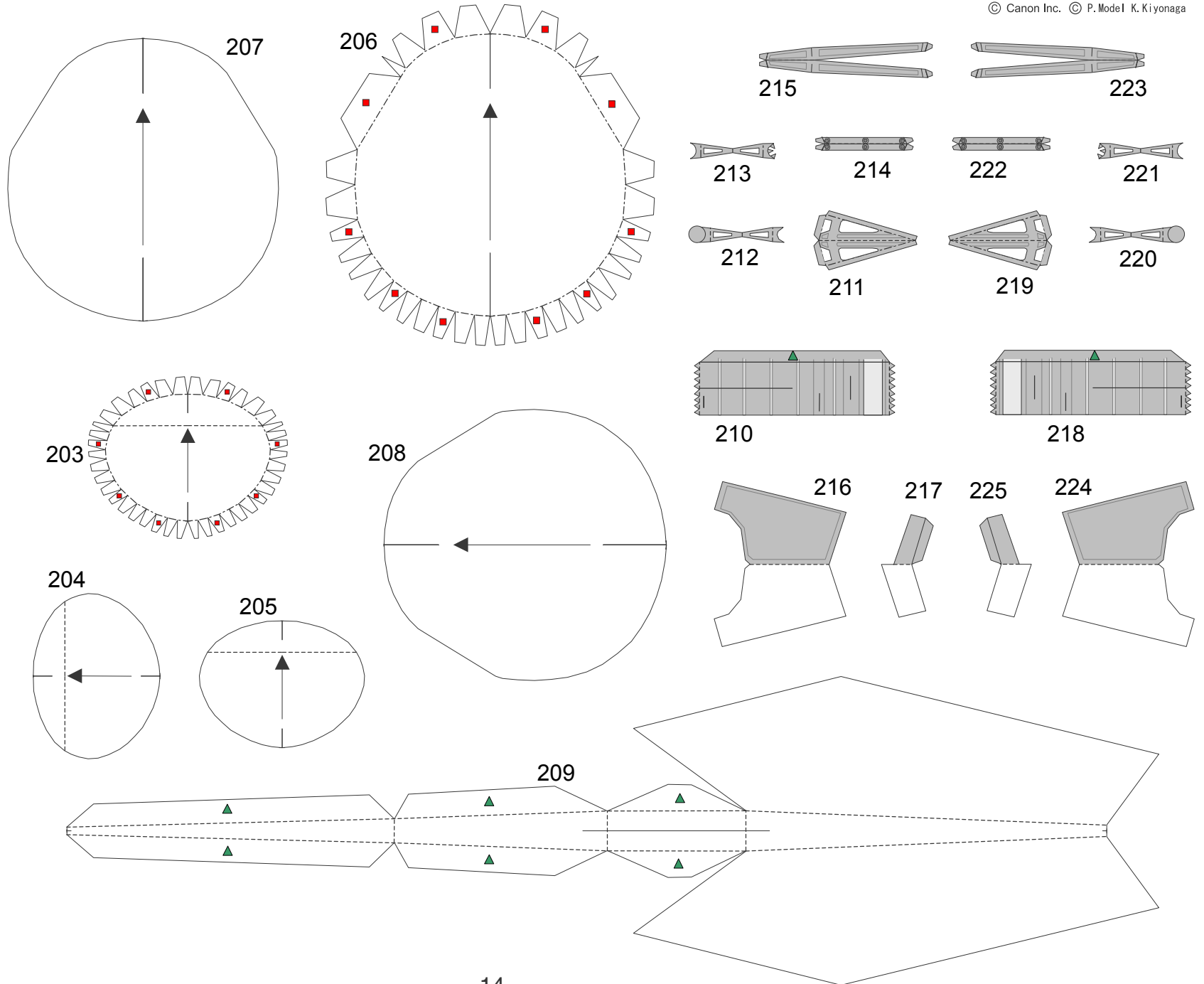



STARFLYER

STARFLYER AIRBUS A320 : PATTERN



Canon® is a registered trademark of Canon Inc.
© Canon Inc. © P. Model K. Kiyonaga

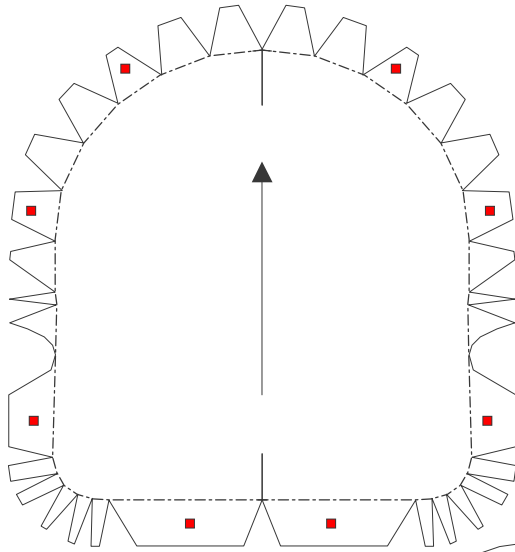

228

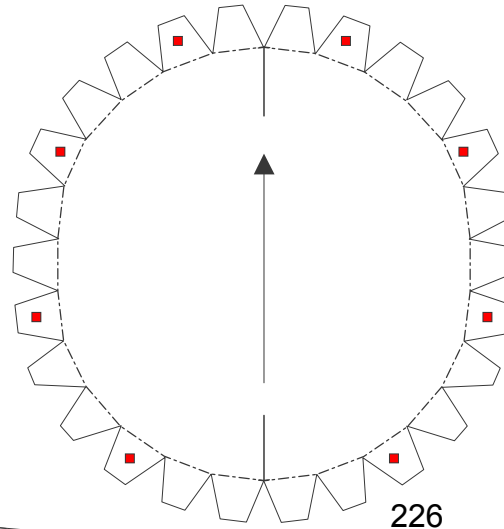

226

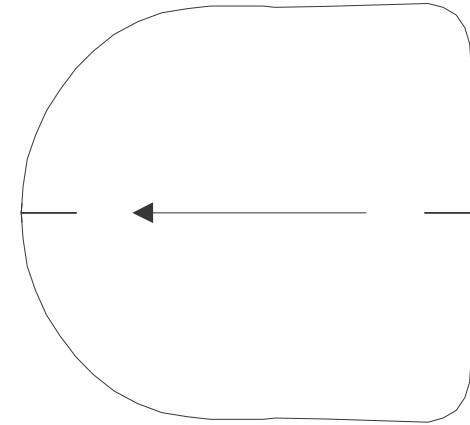

230

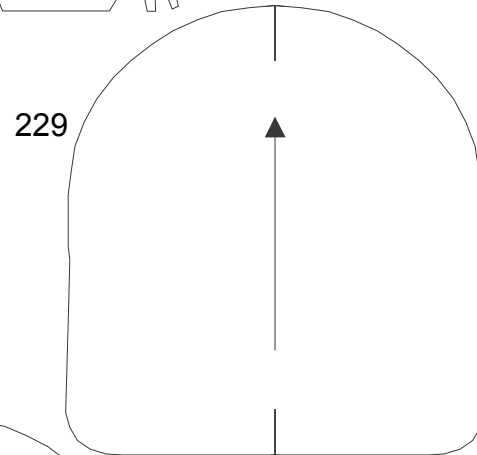

229

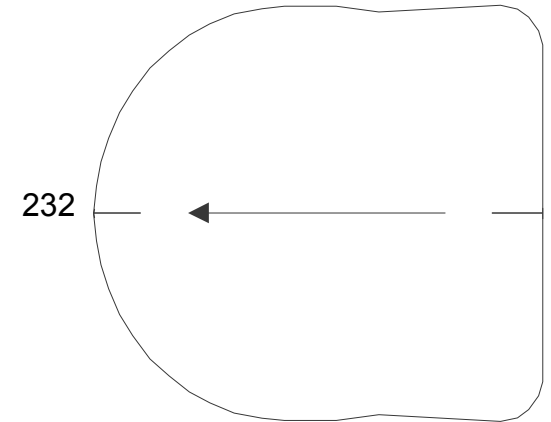

232

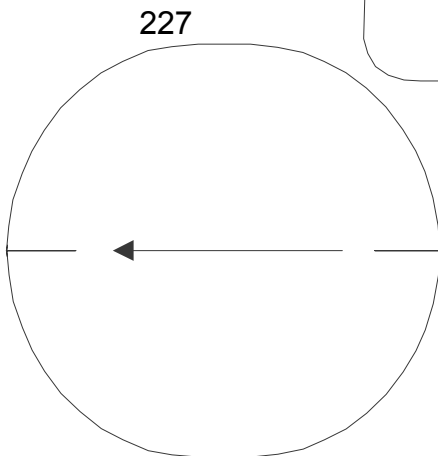

227

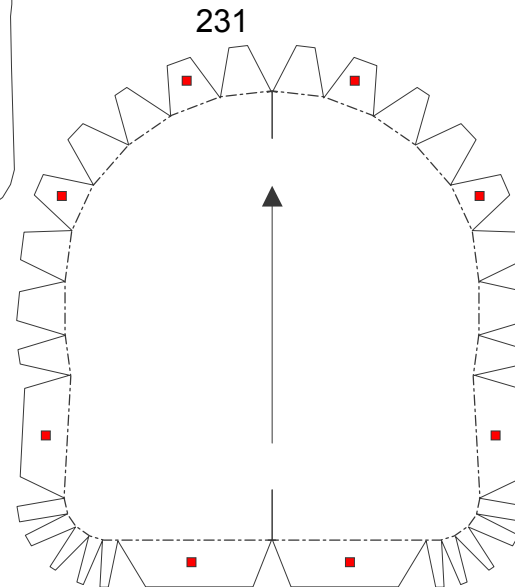

231

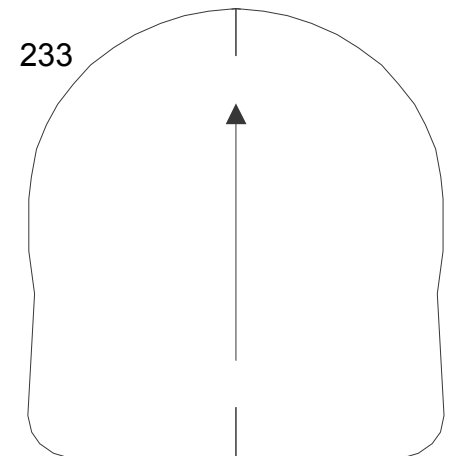

233



STARFLYER

STARFLYER AIRBUS A320 : PATTERN



Canon® is a registered trademark of Canon Inc.
© Canon Inc. © P. Model K. Kiyonaga

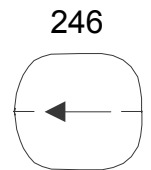
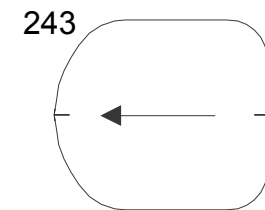
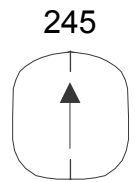
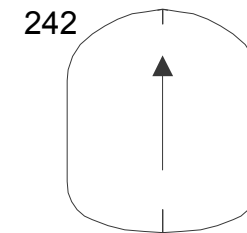
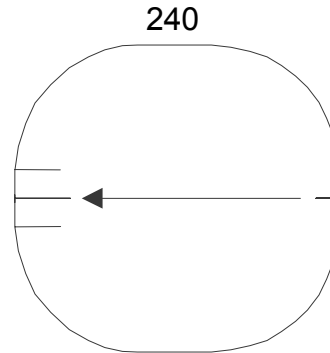
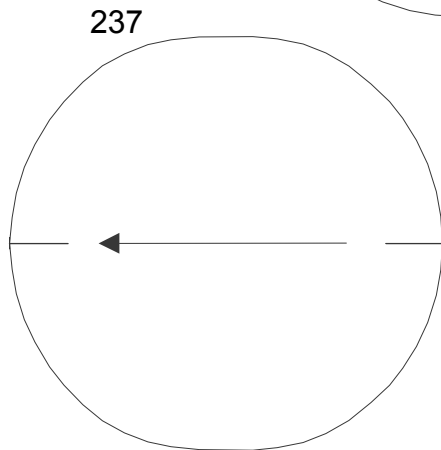
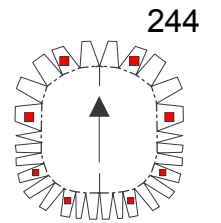
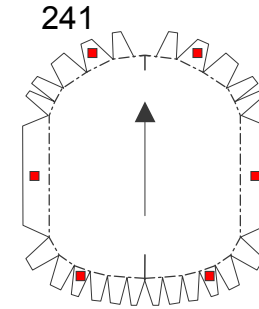
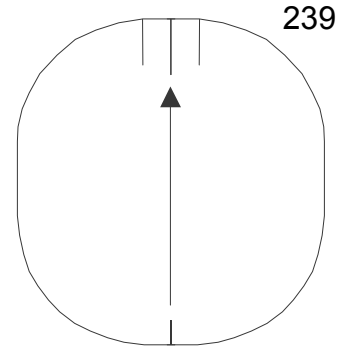
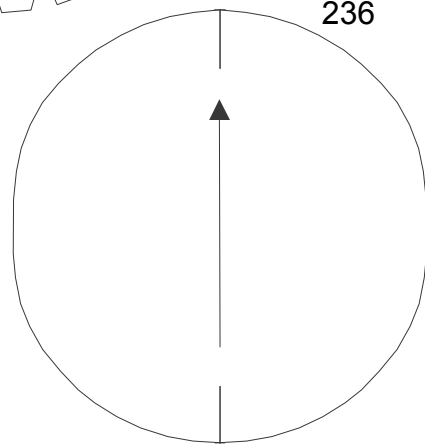
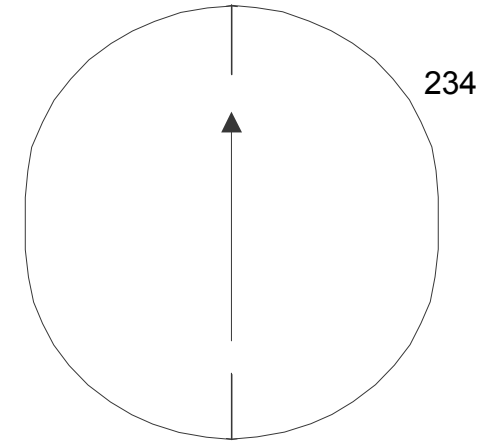
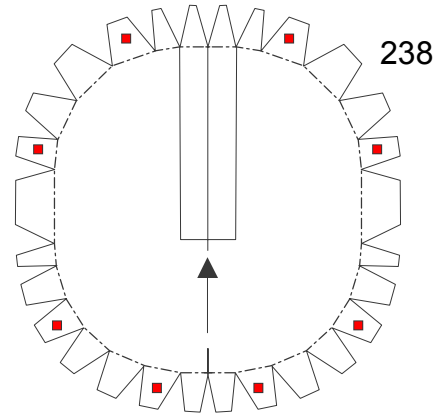
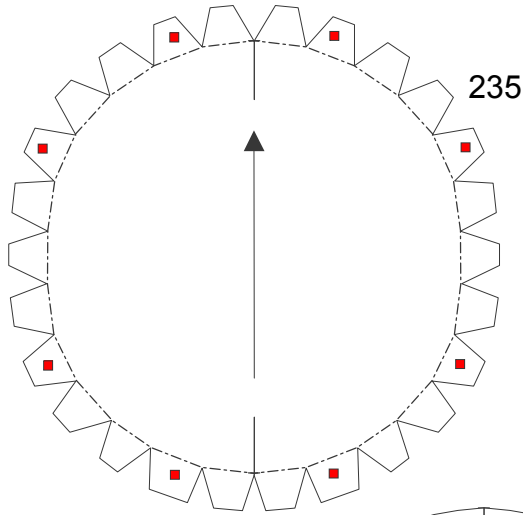



STARFLYER

STARFLYER AIRBUS A320 : PATTERN



Canon® is a registered trademark of Canon Inc.
© Canon Inc. © P. Model K. Kiyonaga

247

248

249

250

251 252 253 254

255

256

257

258

259 260 261 262

263

264

265

266

267 268 269 270

271

272

273

274

275 276 277 278

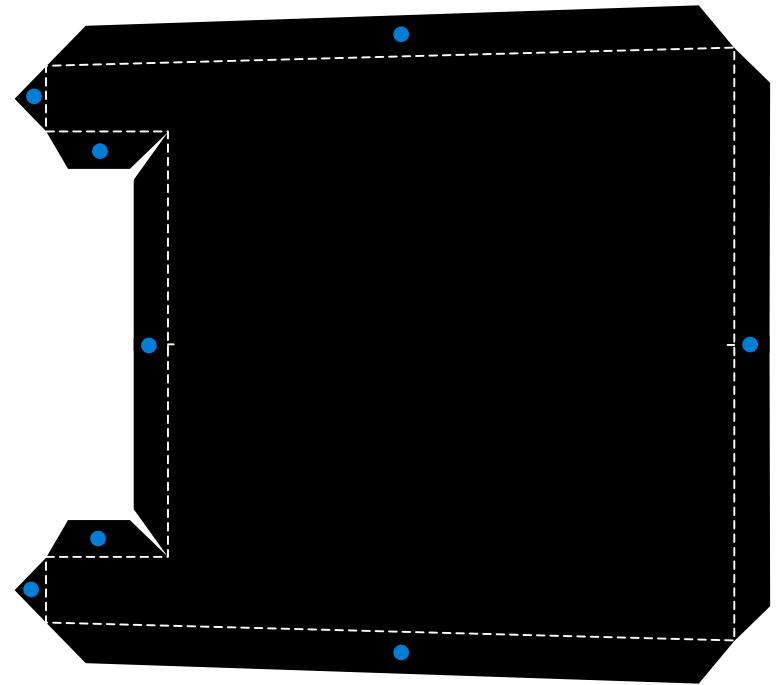
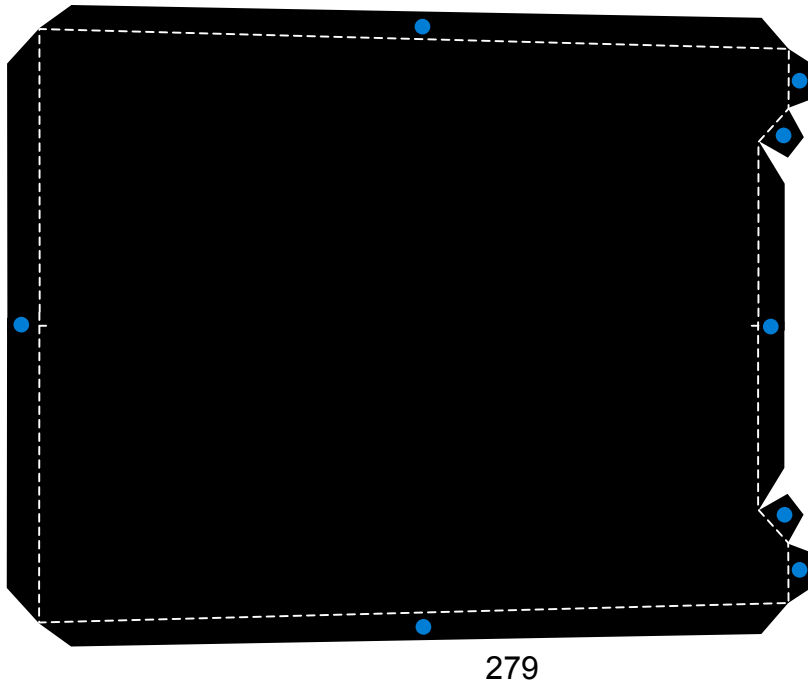



STARFLYER

STARFLYER AIRBUS A320 : PATTERN



Canon® is a registered trademark of Canon Inc.
© Canon Inc. © P.Model K. Kiyonaga

281

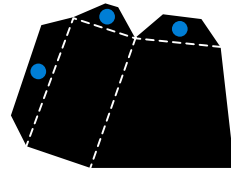

282

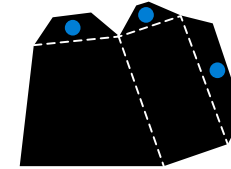

283

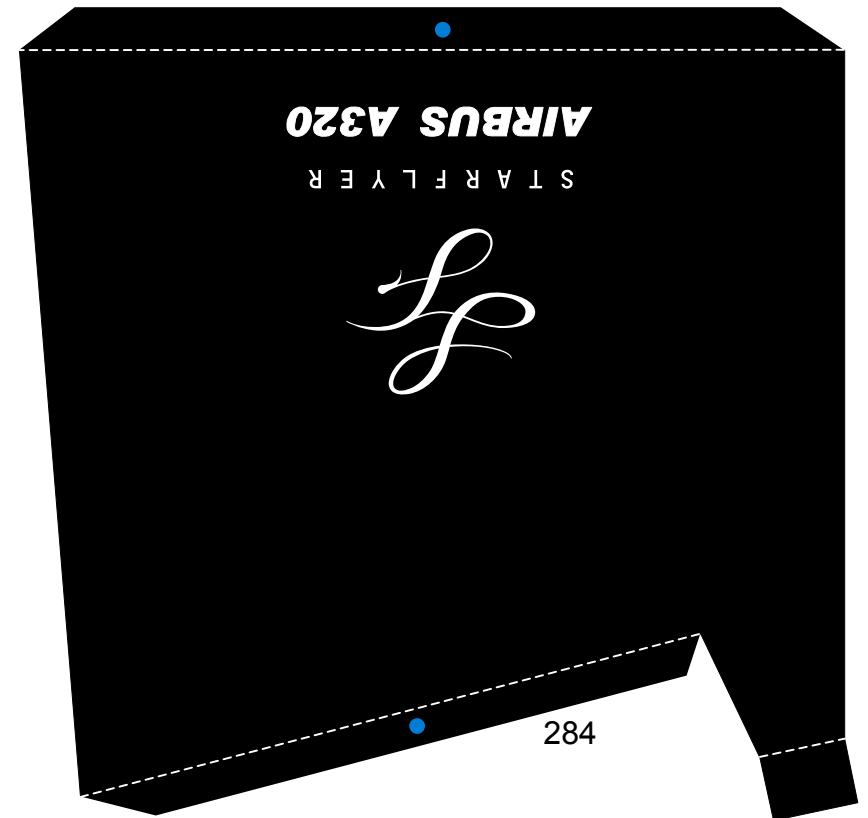

284



STARFLYER

STARFLYER AIRBUS A320 : PATTERN

Canon

Canon® is a registered trademark of Canon Inc.
© Canon Inc. © P. Model K. Kiyonaga

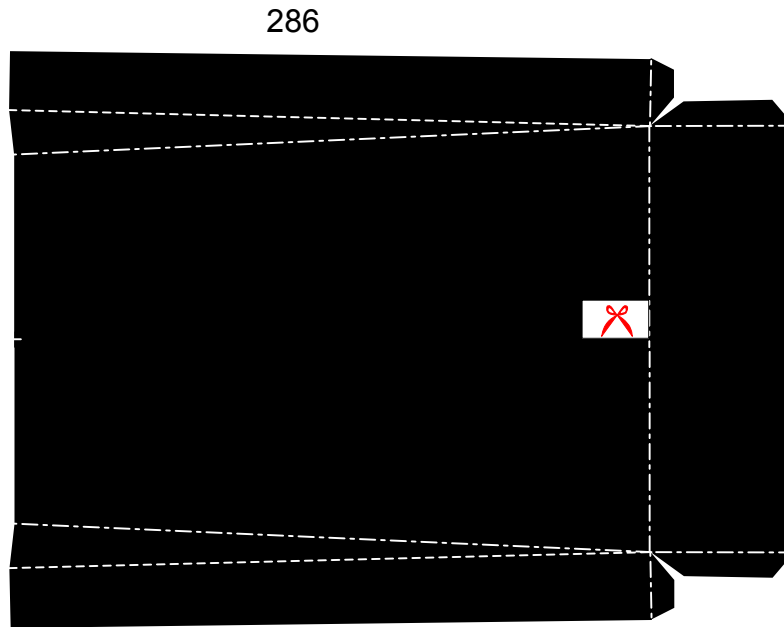



STARFLYER

STARFLYER AIRBUS A320 : ASSEMBLY INSTRUCTIONS



Canon® is a registered trademark of Canon Inc.
© Canon Inc. © P. Model K. Kiyonaga



<http://www.canon.com/c-park/en/>



Front



Over look



Side



Underside



STARFLYER AIRBUS A320

This model is based on the STARFLYER AIRBUS A320, a passenger aircraft manufactured by Airbus and operated by Star Flyer Inc., and covers the route between Tokyo's Haneda Airport and Kitakyushu. This beautifully refined black aircraft was designed with the image of "21st century chic". Seat numbers have been reduced to 144 from the standard 170, allowing 12cm extra legroom for each seat. All seats are covered in leather, and equipped with power outlets for laptop computers, and plasma screen personal TV sets.

The AIRBUS A320 features an overall length of 37.57m and is 11.76m high, with a wingspan of 34.10m.

With a maximum take-off weight of 77 tons and an economical cruising speed of 840 km/h, it can cover distances of up to 5,500 km.

Completed Model (Total length) About 520mm (Scale About 1:72)
(Total width) About 468mm
Pattern 19 pages (No. of Parts: 296)
Assembly Instruction 20 pages

This model was designed for Papercraft and may differ from the original in some respects.

*Build the model by carefully reading the Assembly Instructions, in the parts sheet page order.

Assembly Process

Attach the parts in order.

1 ~ 286 No. of Parts

You can choose to make either a grounded style (with wheels) or an in-flight style (without wheels) aircraft.

***Glue, scissors and other tools may be dangerous to young children so be sure to keep them out of the reach of young children.**

Assembly Tip

- Small pieces will be easier to cut out if you fold along the lines first. Cut them out after you have folded them.
- Before gluing each piece, be sure to compare its shape to the corresponding surface to ensure it is the correct piece.

Folds & Marks

Trace along the folds with a ruler and a used pen (no ink) to get a sharper, easier fold.

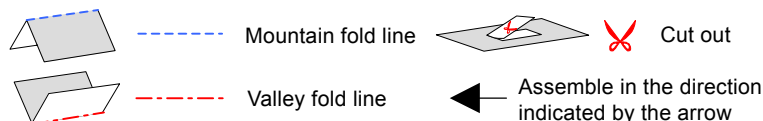

Glue spot

Each glue spot has a mark indicating how to attach it.

- Glue to the rear of the other part
- ▲ Glue within the same part
- Glue the rear of this part

Tools

Scissors, glue (We recommend craft glue), ruler, tweezers, stencil pen, used pen (no ink).



STARFLYER

STARFLYER AIRBUS A320 : ASSEMBLY INSTRUCTIONS



Canon® is a registered trademark of Canon Inc.
© Canon Inc. © P. Model K. Kiyonaga

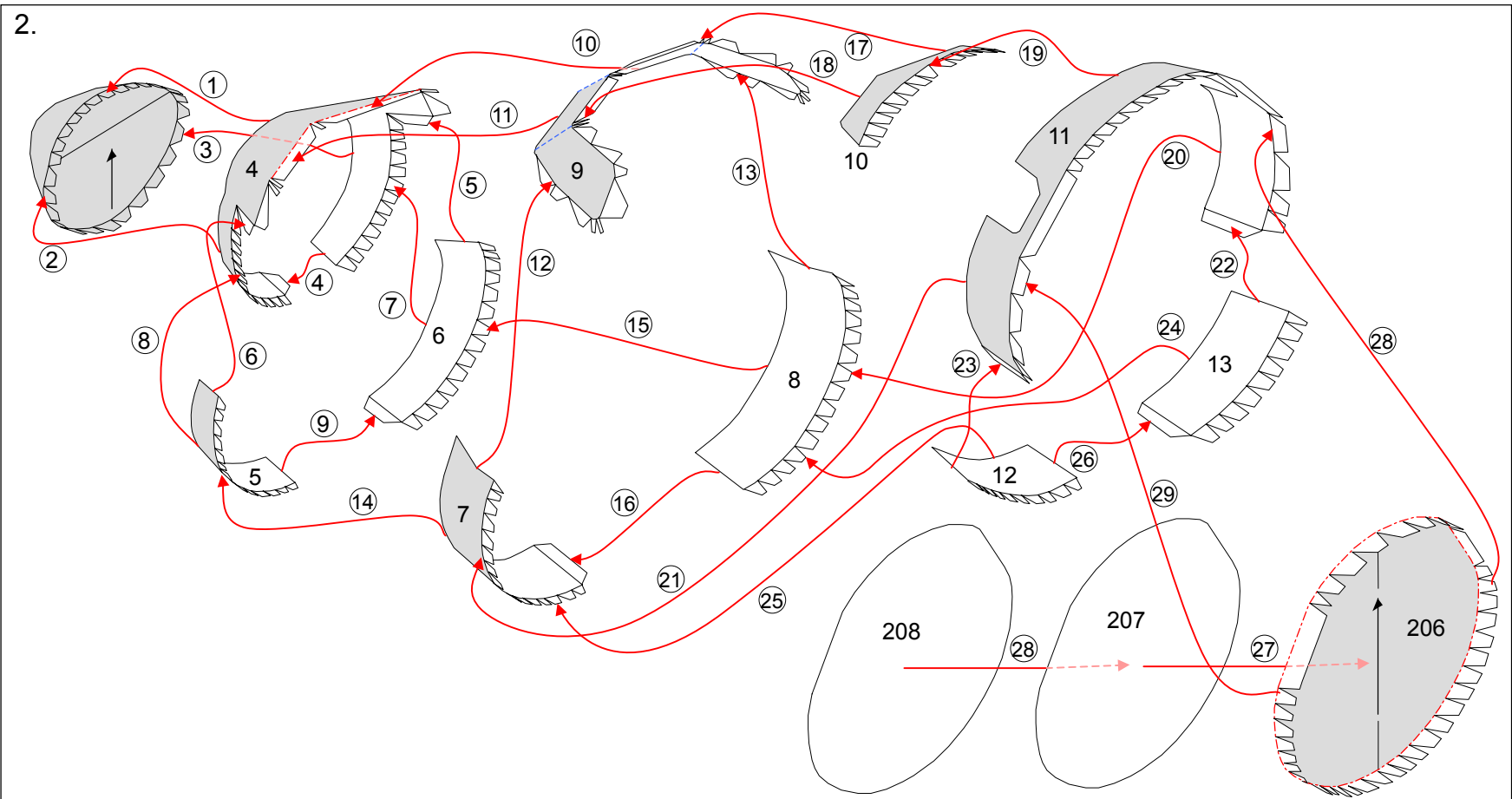
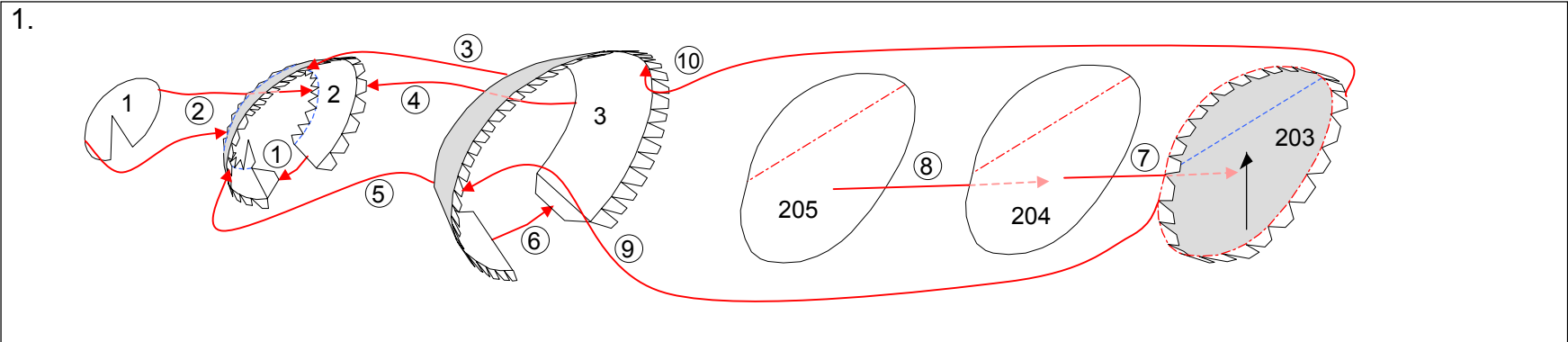



STARFLYER

STARFLYER AIRBUS A320 : ASSEMBLY INSTRUCTIONS



Canon® is a registered trademark of Canon Inc.
© Canon Inc. © P. Model K. Kiyonaga

3. Choose whether to make a grounded model or in-flight model.

If making a grounded model

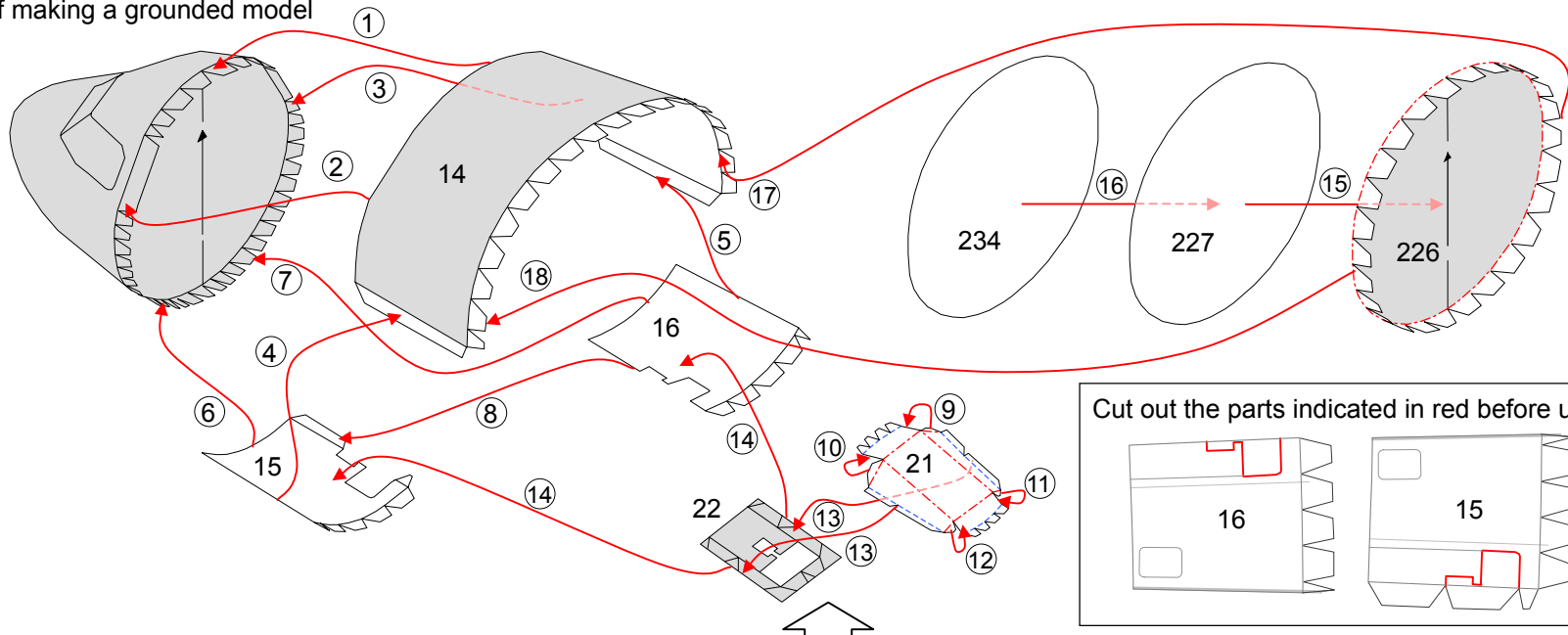

If making a grounded model

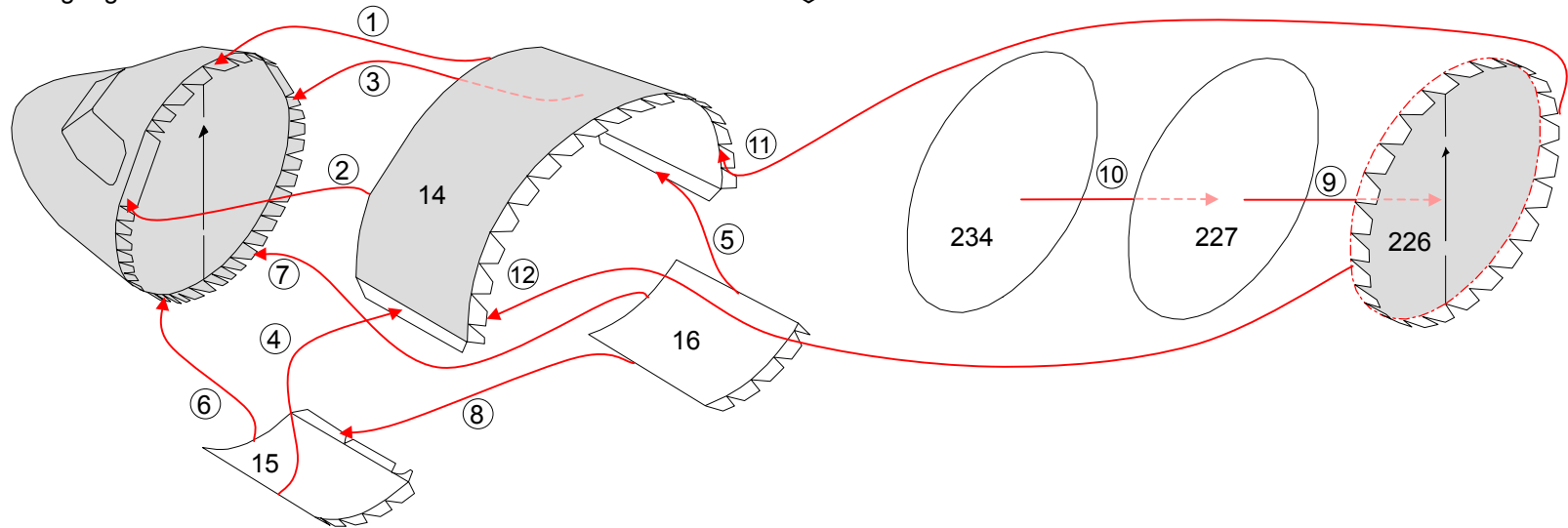



STARFLYER

STARFLYER AIRBUS A320 : ASSEMBLY INSTRUCTIONS



Canon® is a registered trademark of Canon Inc.
© Canon Inc. © P. Model K. Kiyonaga

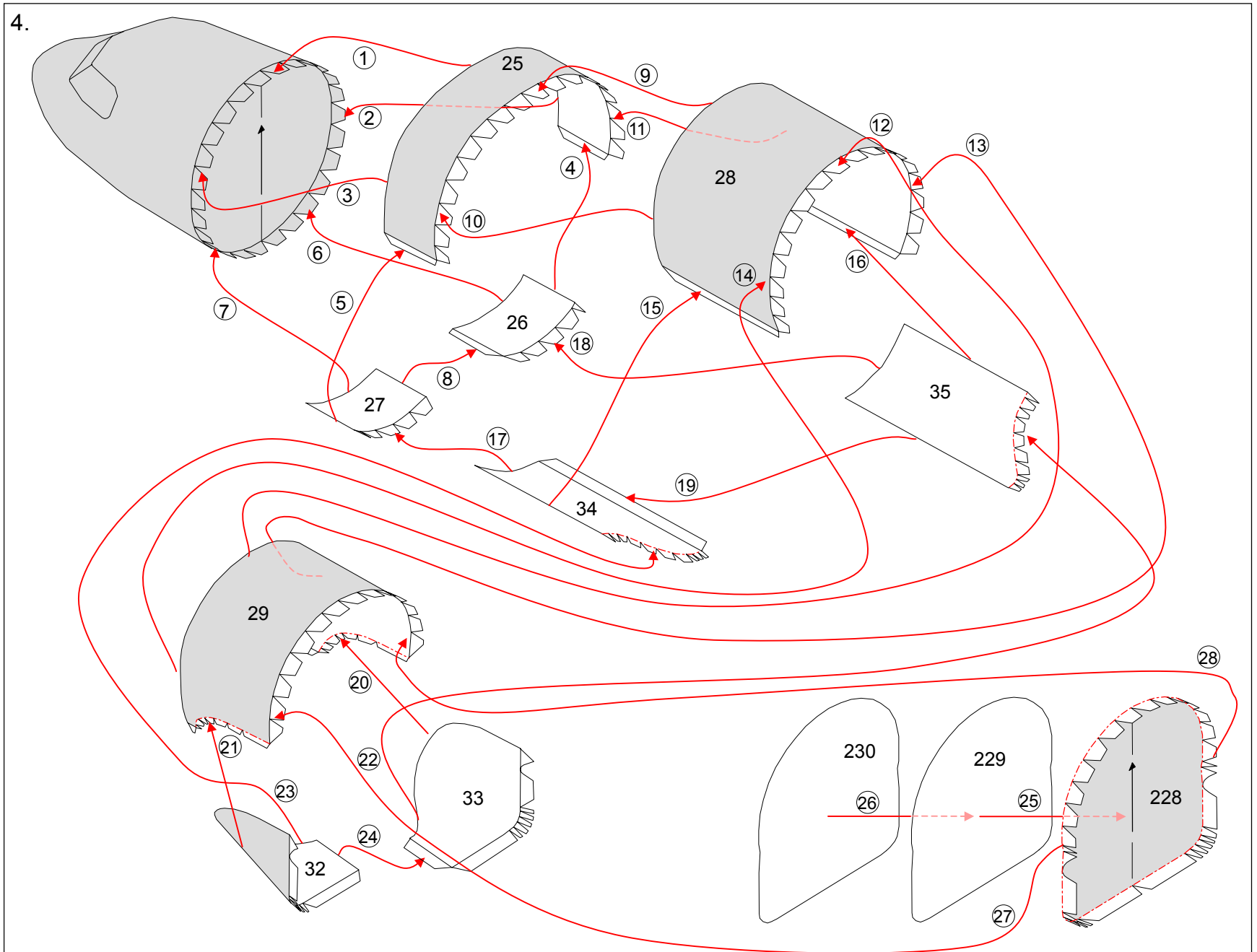



STARFLYER

STARFLYER AIRBUS A320 : ASSEMBLY INSTRUCTIONS



Canon® is a registered trademark of Canon Inc.
© Canon Inc. © P. Model K. Kiyonaga

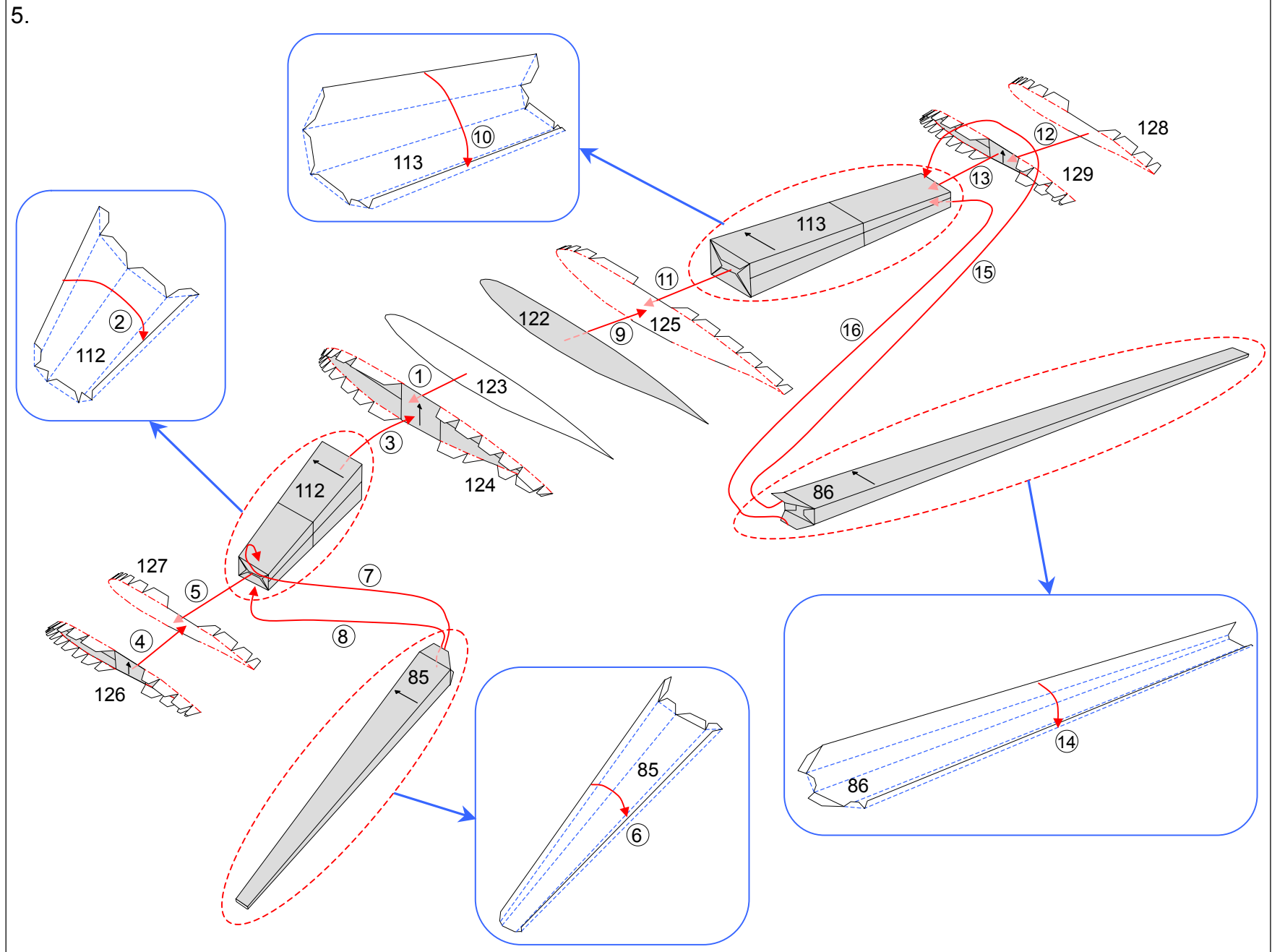



STARFLYER

STARFLYER AIRBUS A320 : ASSEMBLY INSTRUCTIONS



Canon® is a registered trademark of Canon Inc.
© Canon Inc. © P. Model K. Kiyonaga

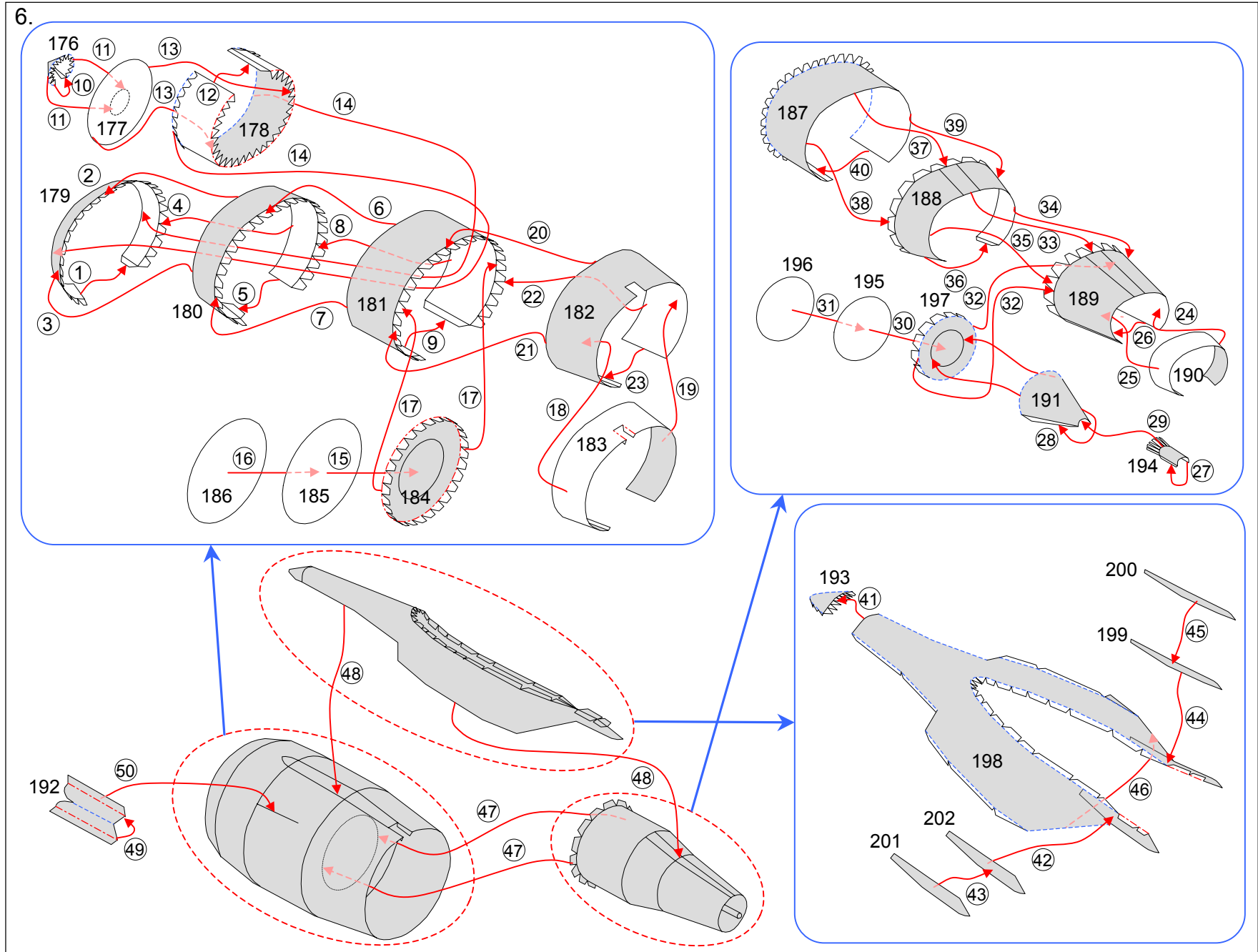



STARFLYER

STARFLYER AIRBUS A320 : ASSEMBLY INSTRUCTIONS



Canon® is a registered trademark of Canon Inc.
© Canon Inc. © P. Model K. Kiyonaga

7.

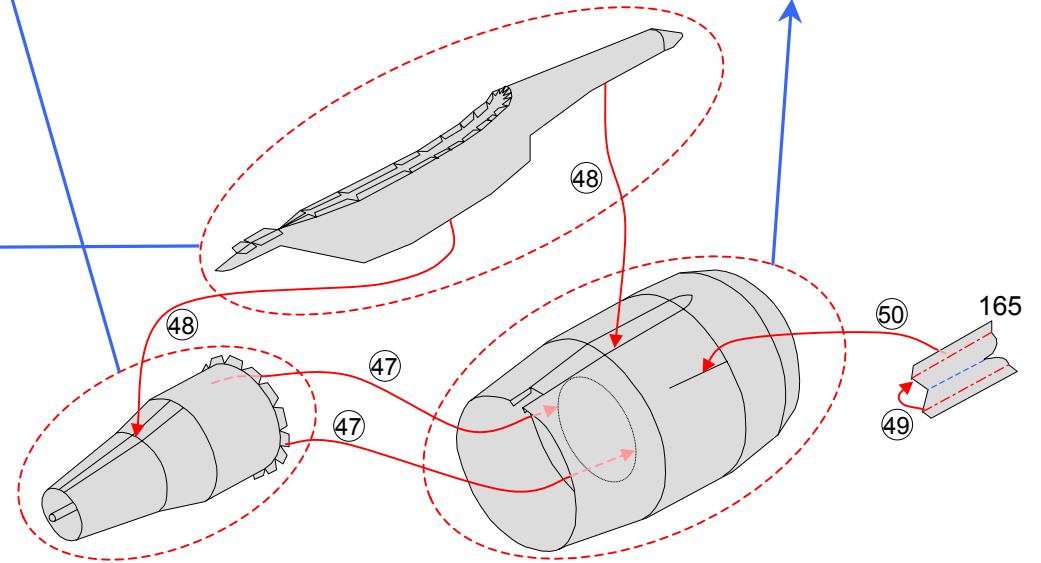
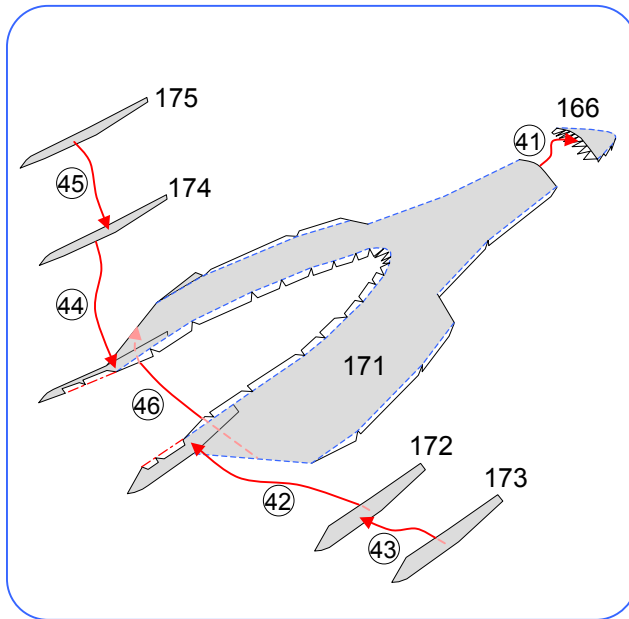
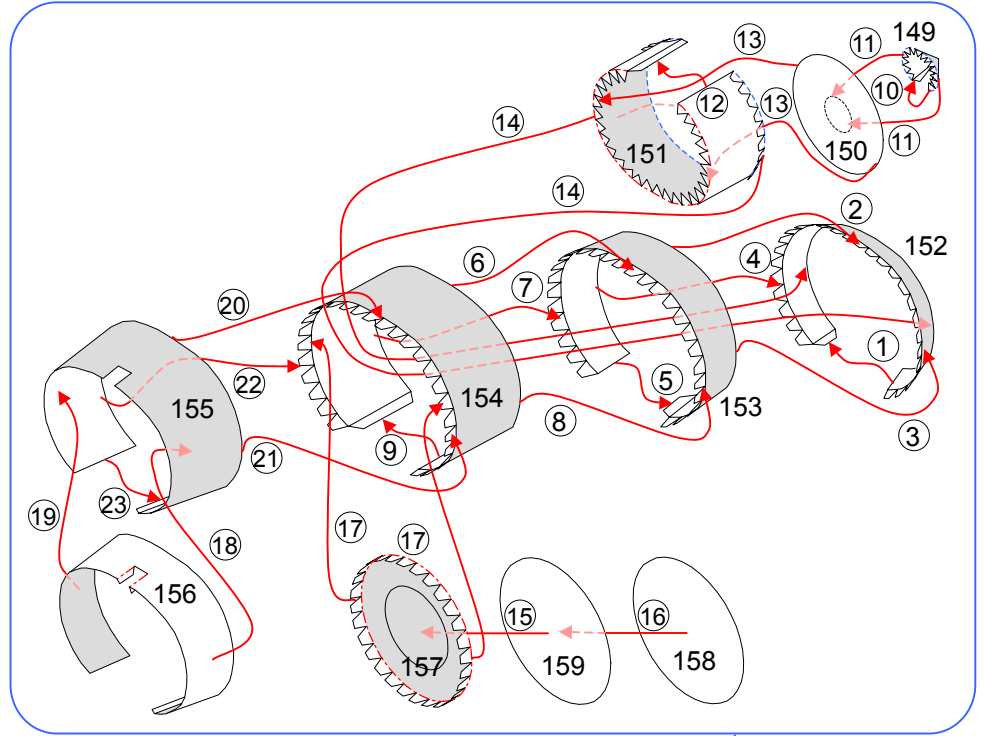
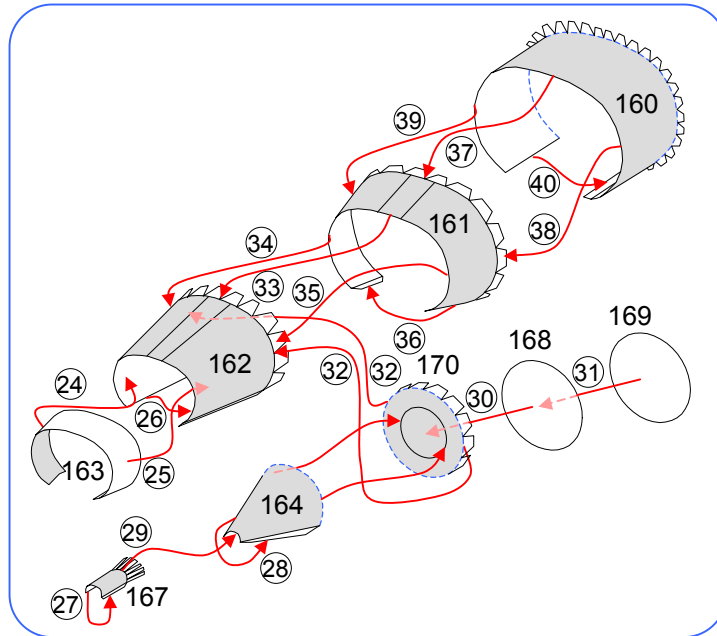



STARFLYER

STARFLYER AIRBUS A320 : ASSEMBLY INSTRUCTIONS



Canon® is a registered trademark of Canon Inc.
© Canon Inc. © P. Model K. Kiyonaga

8. If making an in-flight model, cut out and remove the areas of parts 120 and 121 indicated in red.

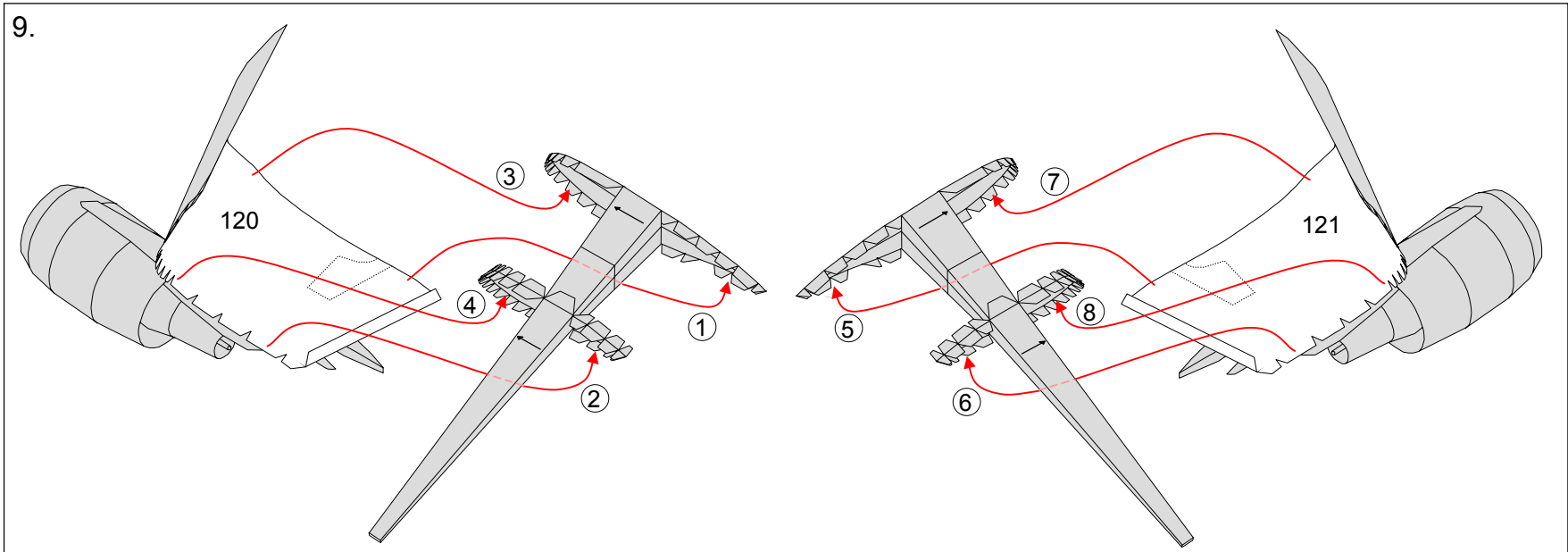
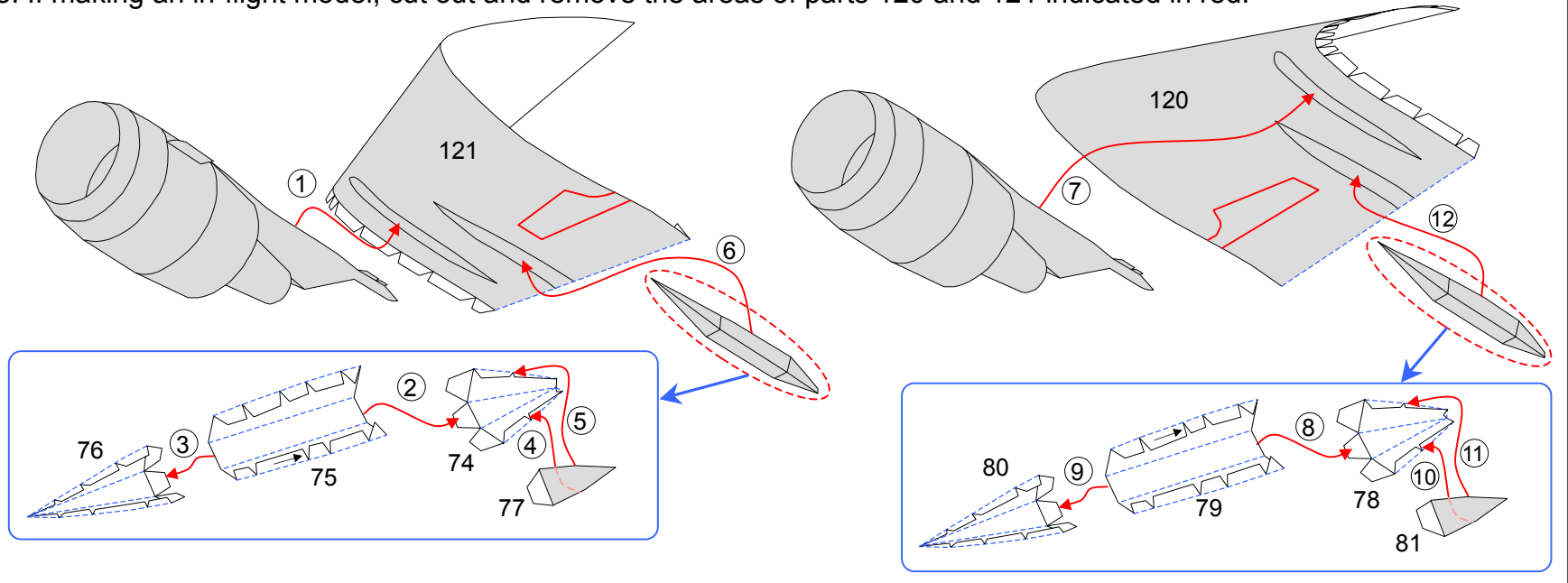



STARFLYER

STARFLYER AIRBUS A320 : ASSEMBLY INSTRUCTIONS



Canon® is a registered trademark of Canon Inc.
© Canon Inc. © P. Model K. Kiyonaga

10. Choose whether to make a grounded model or in-flight model.

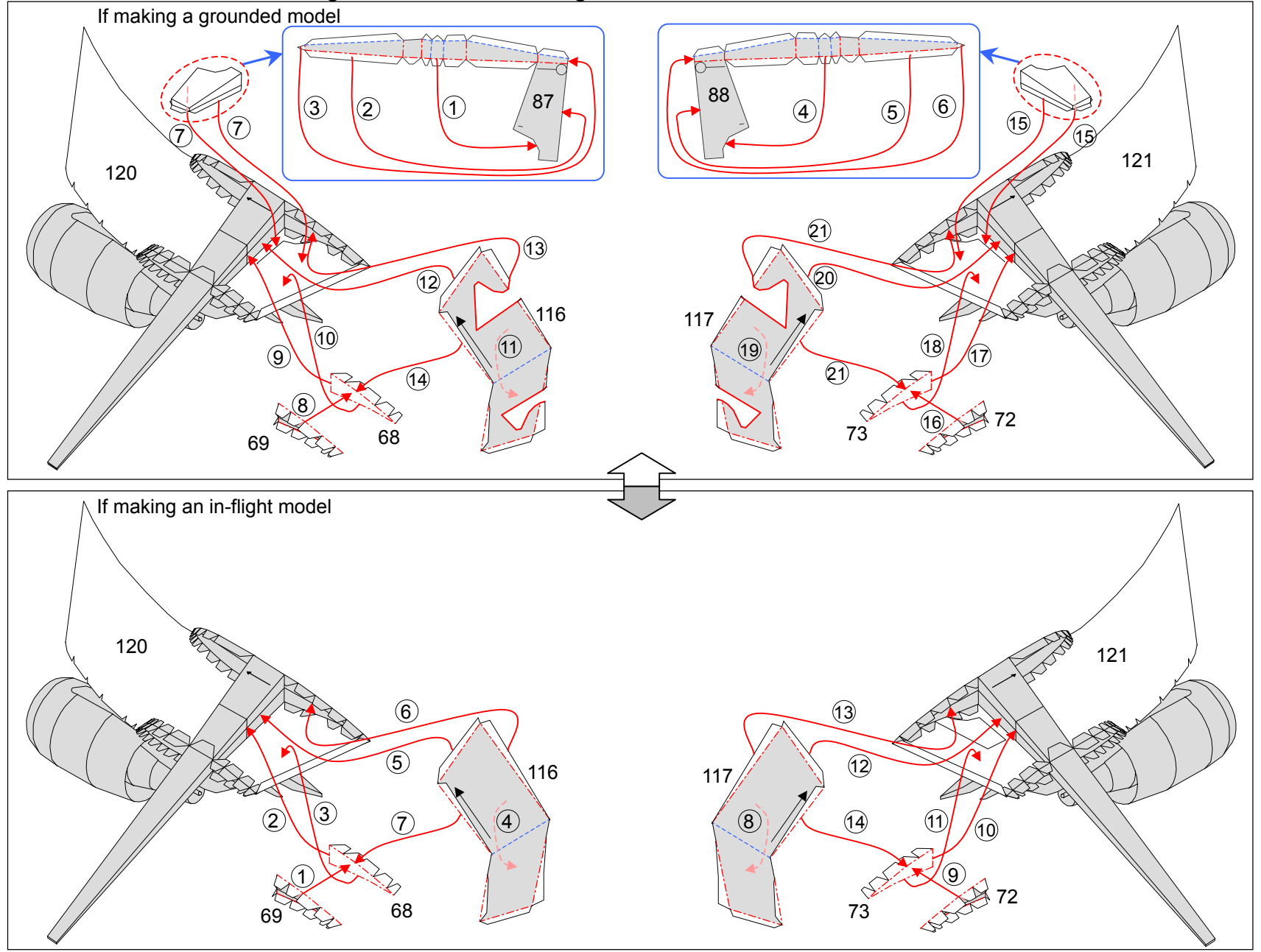



STARFLYER

STARFLYER AIRBUS A320 : ASSEMBLY INSTRUCTIONS



Canon® is a registered trademark of Canon Inc.
© Canon Inc. © P. Model K. Kiyonaga

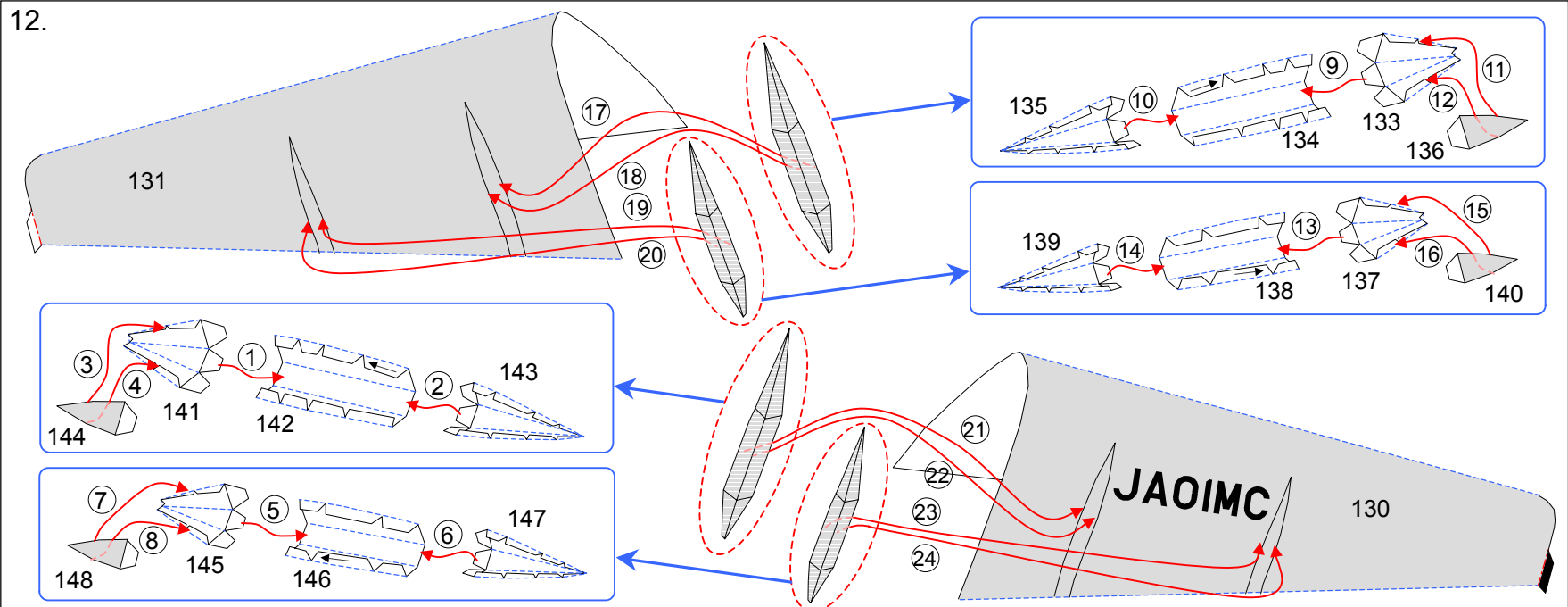
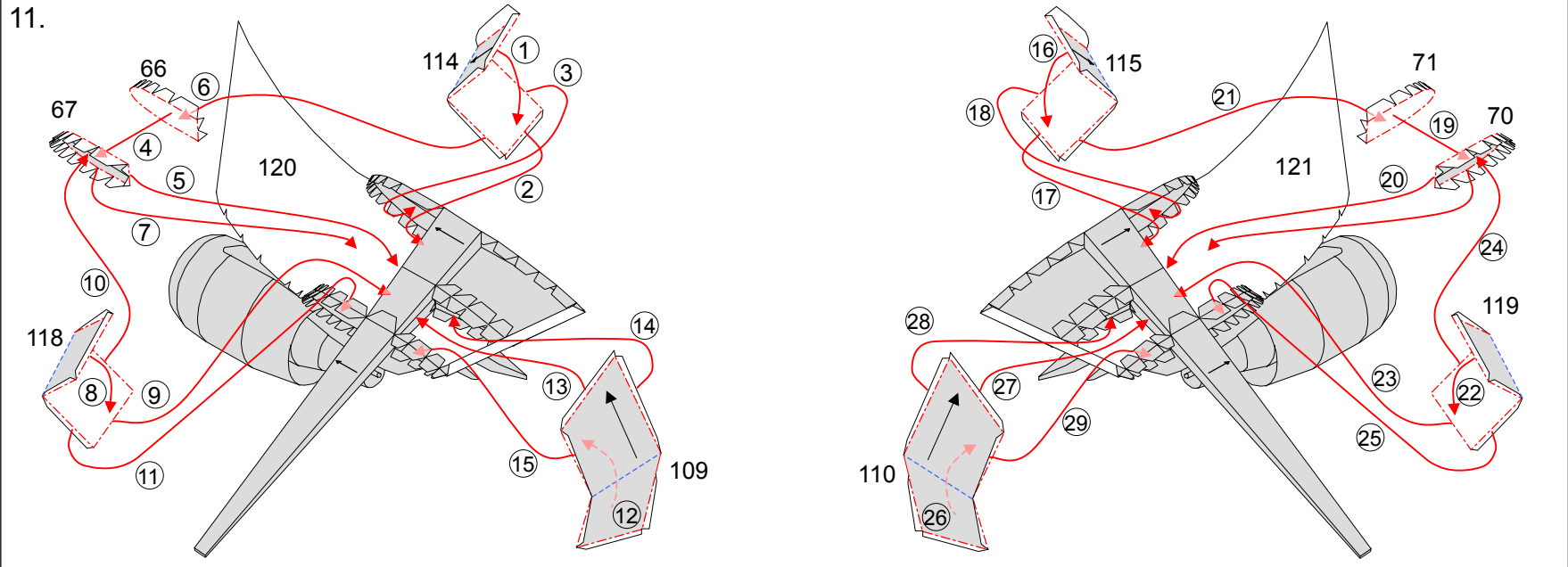



STARFLYER

STARFLYER AIRBUS A320 : ASSEMBLY INSTRUCTIONS



Canon® is a registered trademark of Canon Inc.
© Canon Inc. © P. Model K. Kiyonaga

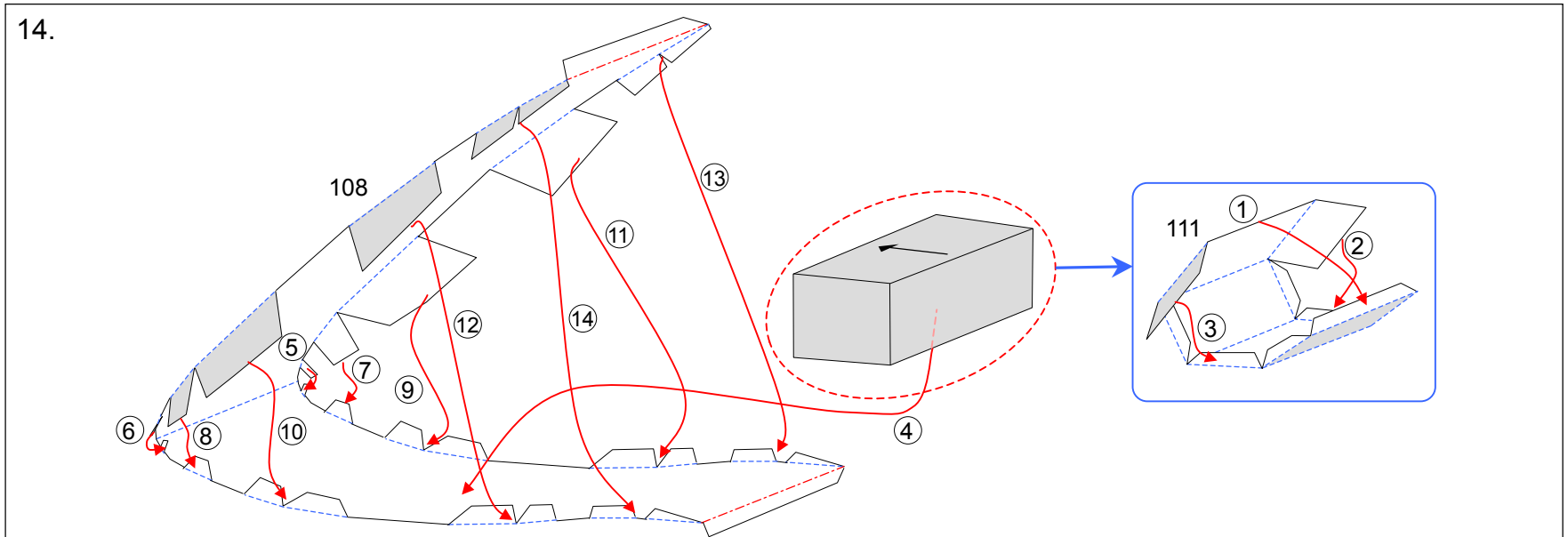
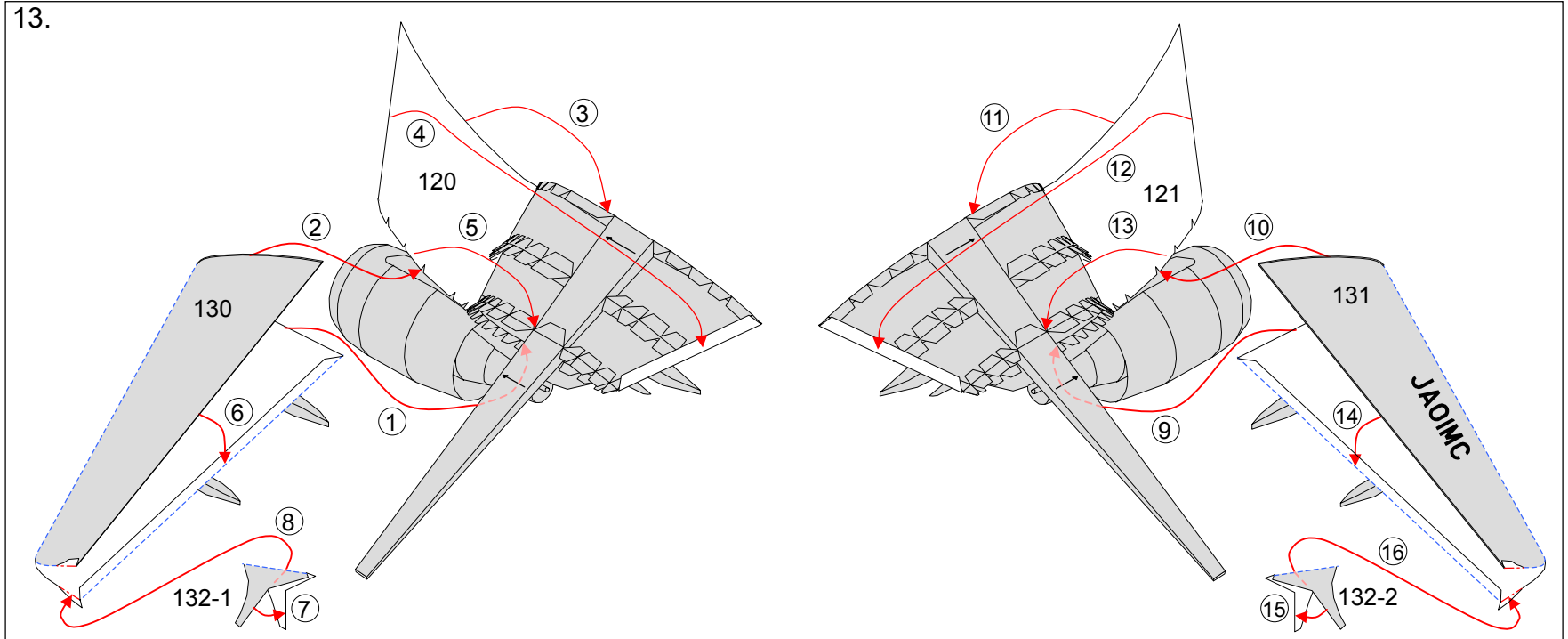



STARFLYER

STARFLYER AIRBUS A320 : ASSEMBLY INSTRUCTIONS



Canon® is a registered trademark of Canon Inc.
© Canon Inc. © P. Model K. Kiyonaga

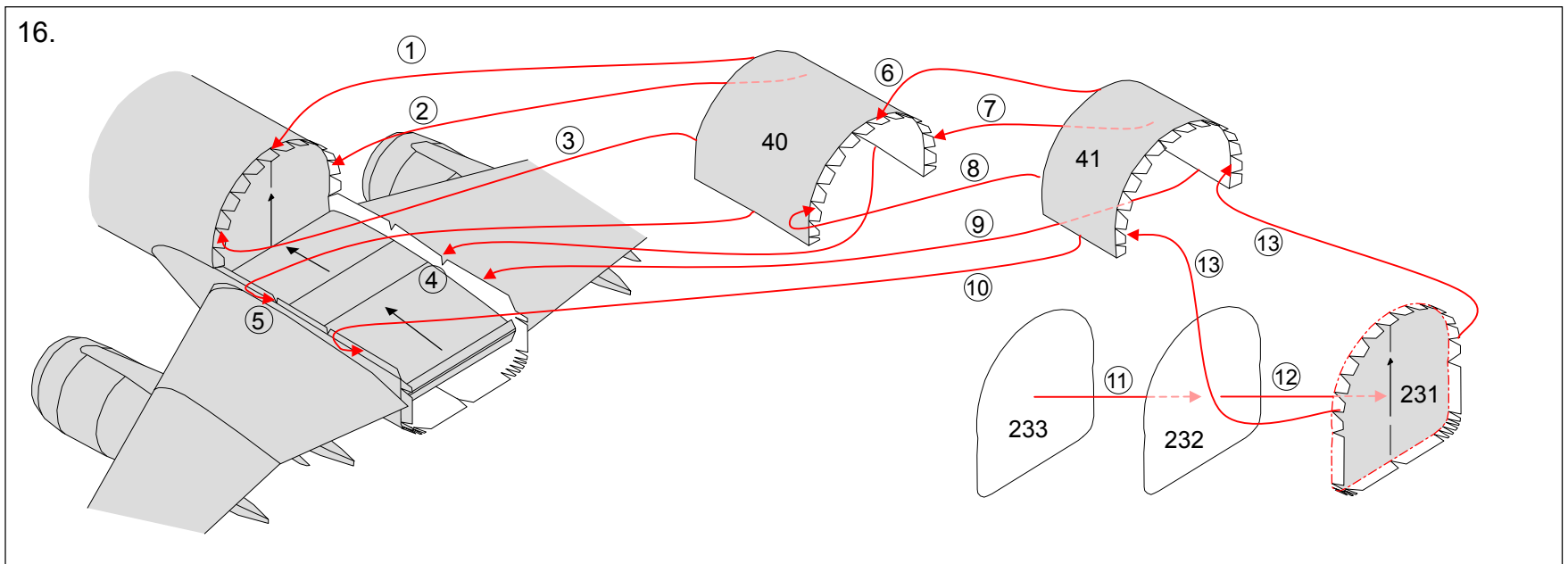
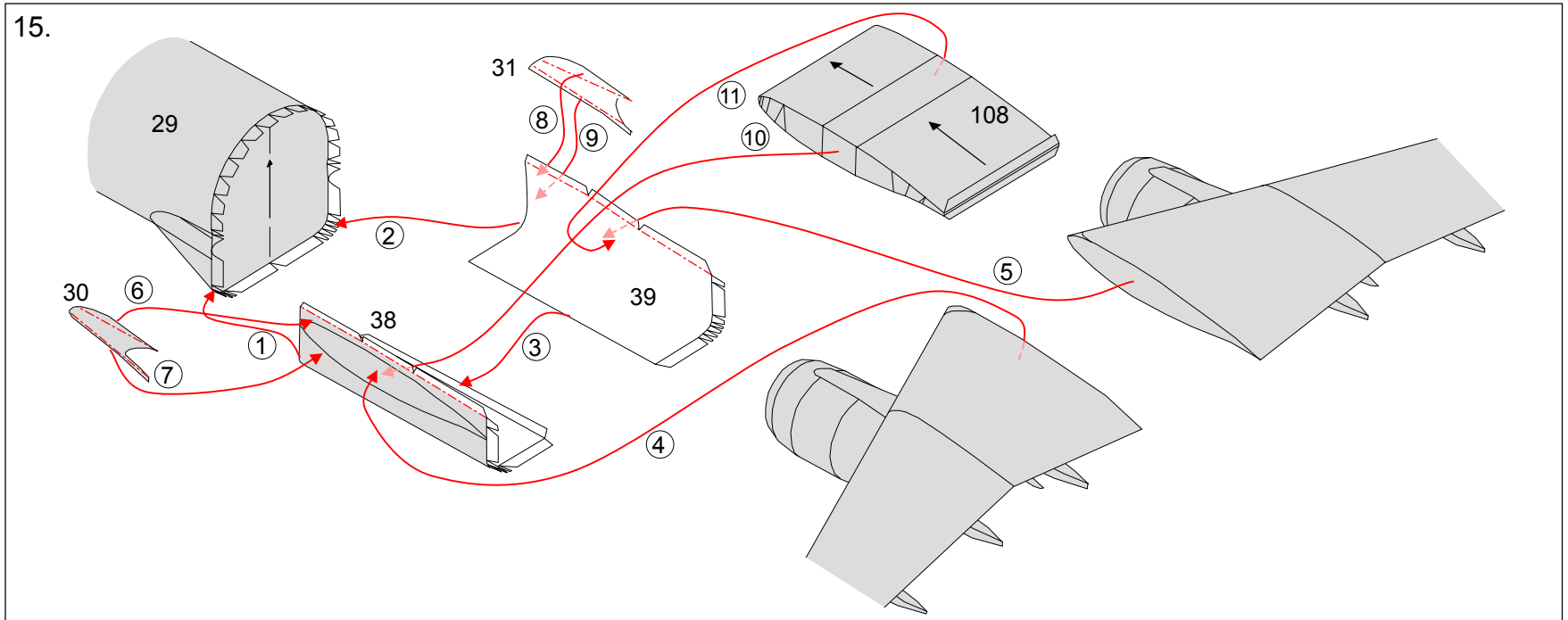



STARFLYER

STARFLYER AIRBUS A320 : ASSEMBLY INSTRUCTIONS



Canon® is a registered trademark of Canon Inc.
© Canon Inc. © P. Model K. Kiyonaga

19.

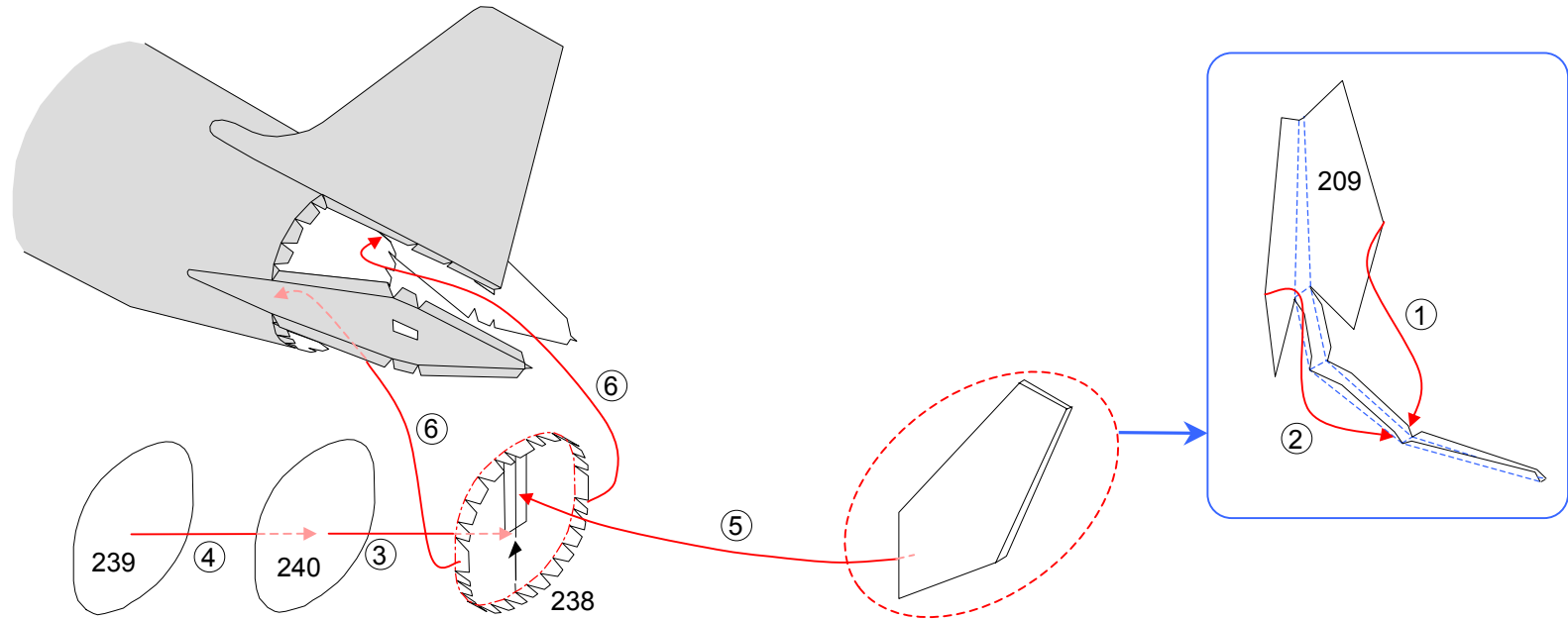

20.

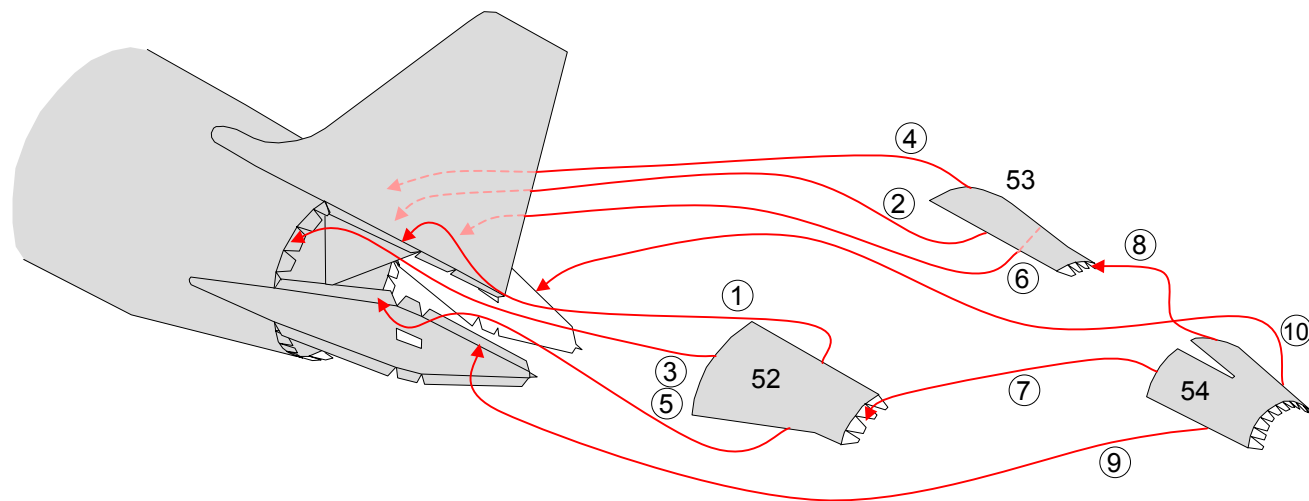



STARFLYER

STARFLYER AIRBUS A320 : ASSEMBLY INSTRUCTIONS



Canon® is a registered trademark of Canon Inc.
© Canon Inc. © P. Model K. Kiyonaga

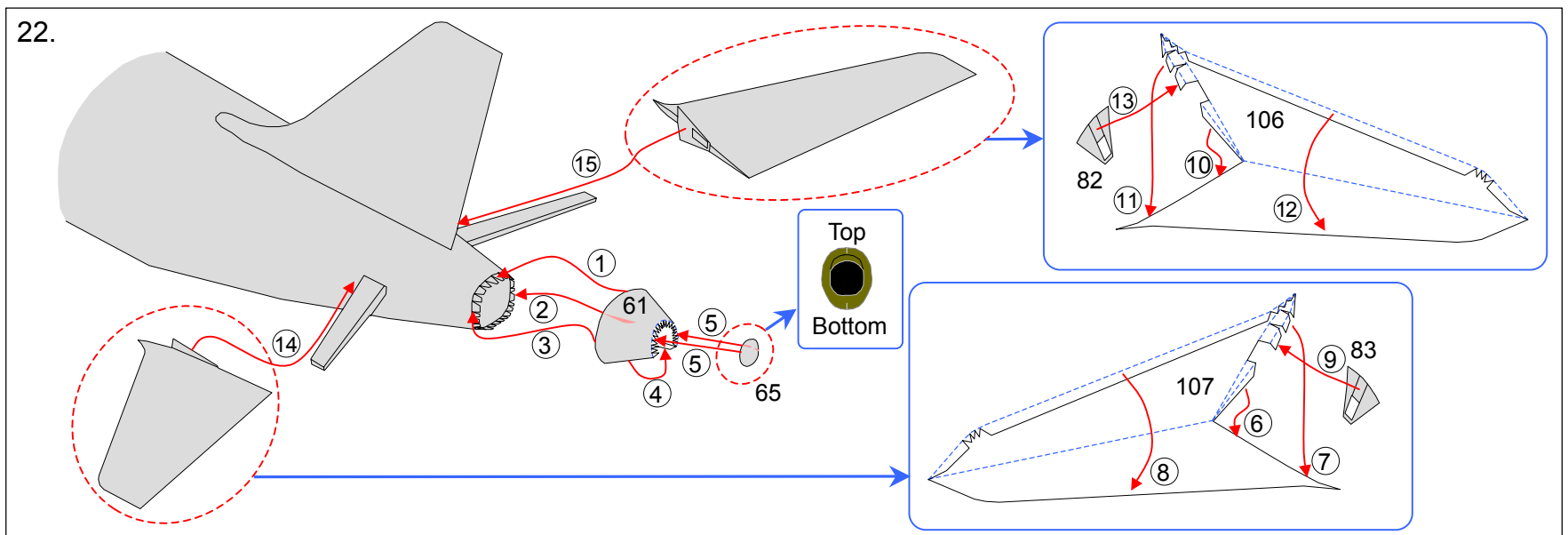
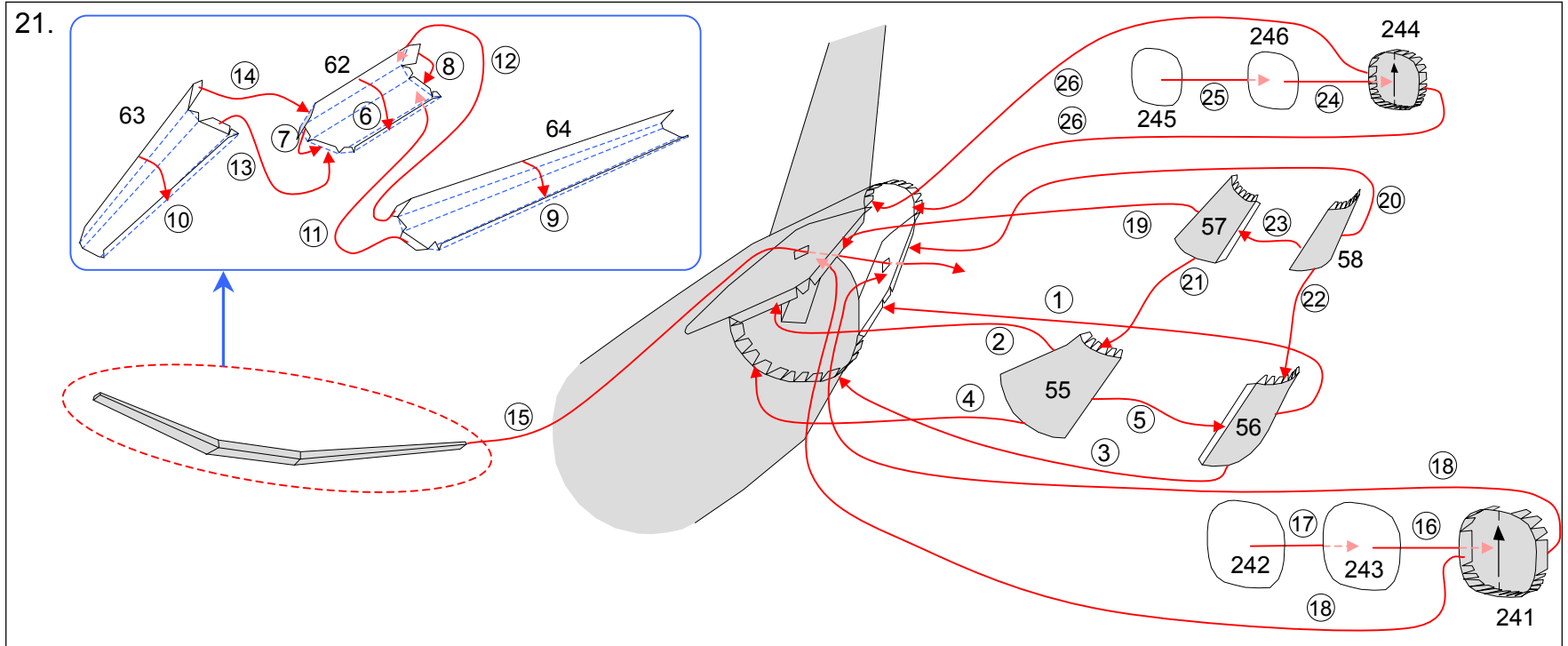



STARFLYER

STARFLYER AIRBUS A320 : ASSEMBLY INSTRUCTIONS



Canon® is a registered trademark of Canon Inc.
© Canon Inc. © P. Model K. Kiyonaga

23. Carry out this step if making a grounded model

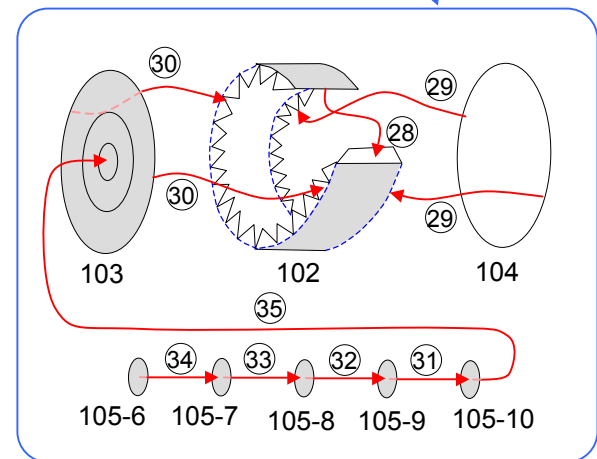
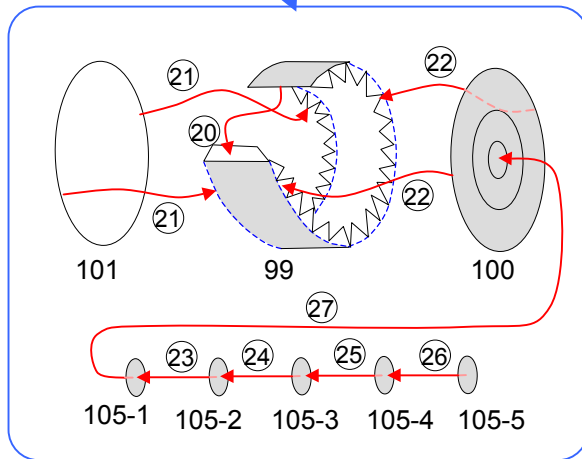
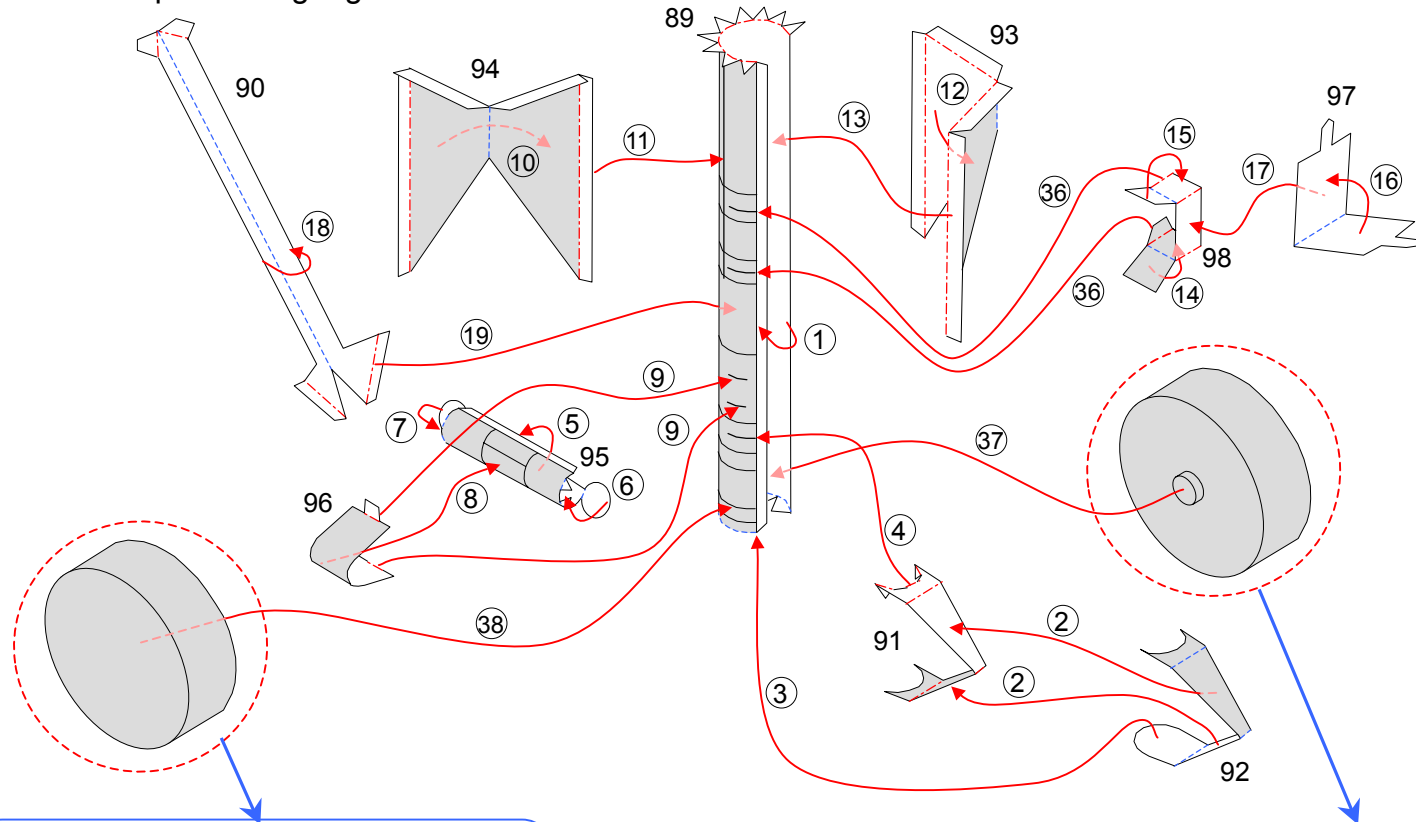



STARFLYER

STARFLYER AIRBUS A320 : ASSEMBLY INSTRUCTIONS



Canon® is a registered trademark of Canon Inc.
© Canon Inc. © P. Model K. Kiyonaga

24. Carry out this step if making a grounded model

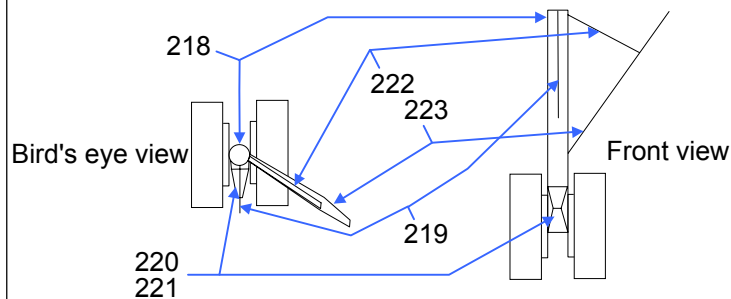
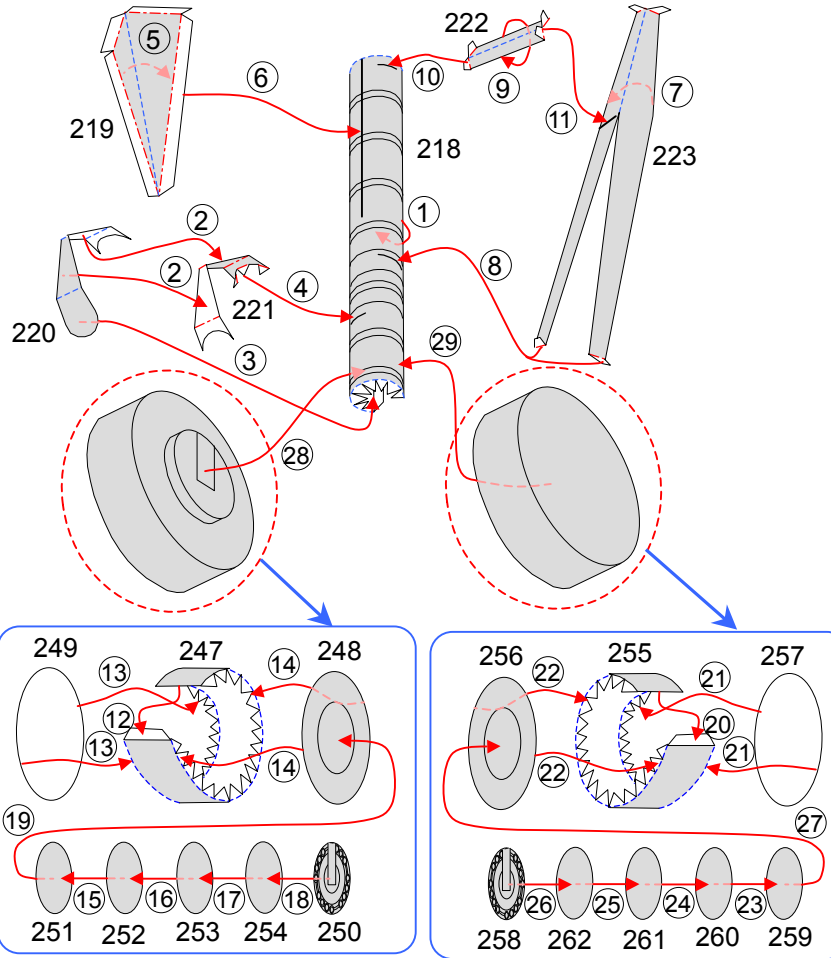

25. Carry out this step if making a grounded model

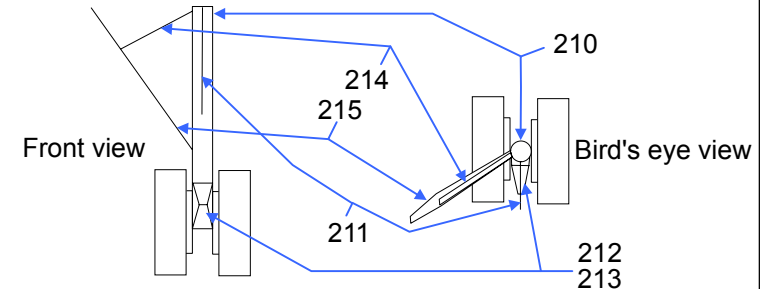
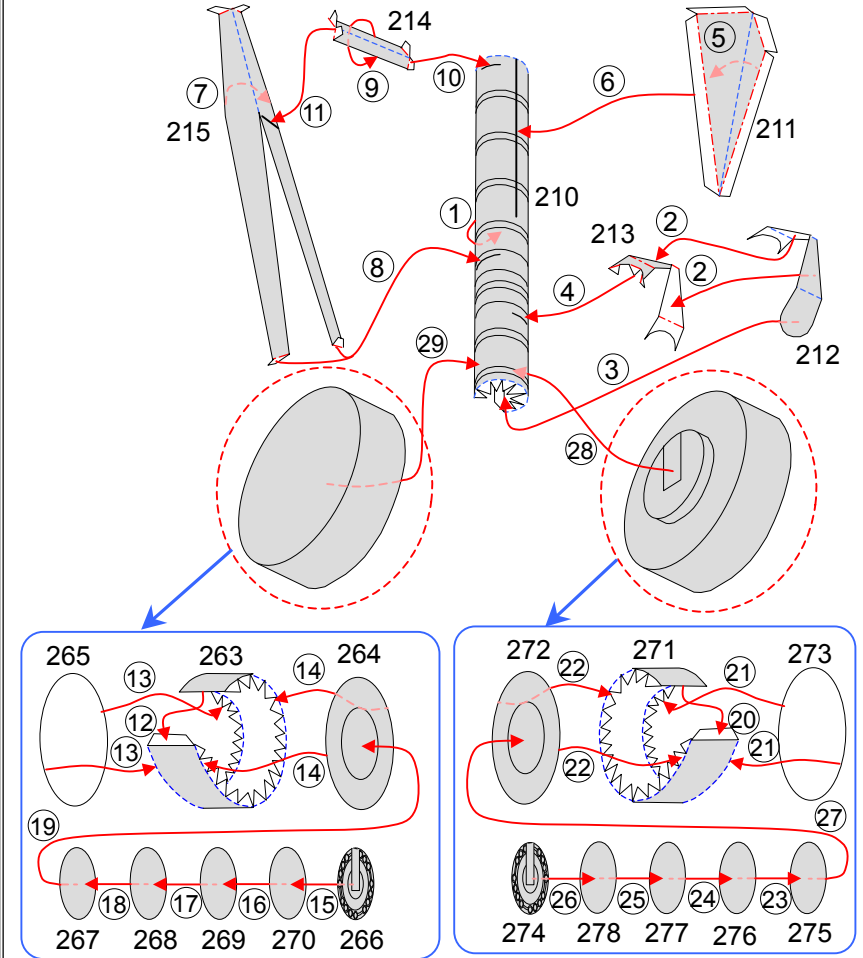



STARFLYER

STARFLYER AIRBUS A320 : ASSEMBLY INSTRUCTIONS



Canon® is a registered trademark of Canon Inc.
© Canon Inc. © P. Model K. Kiyonaga

26.

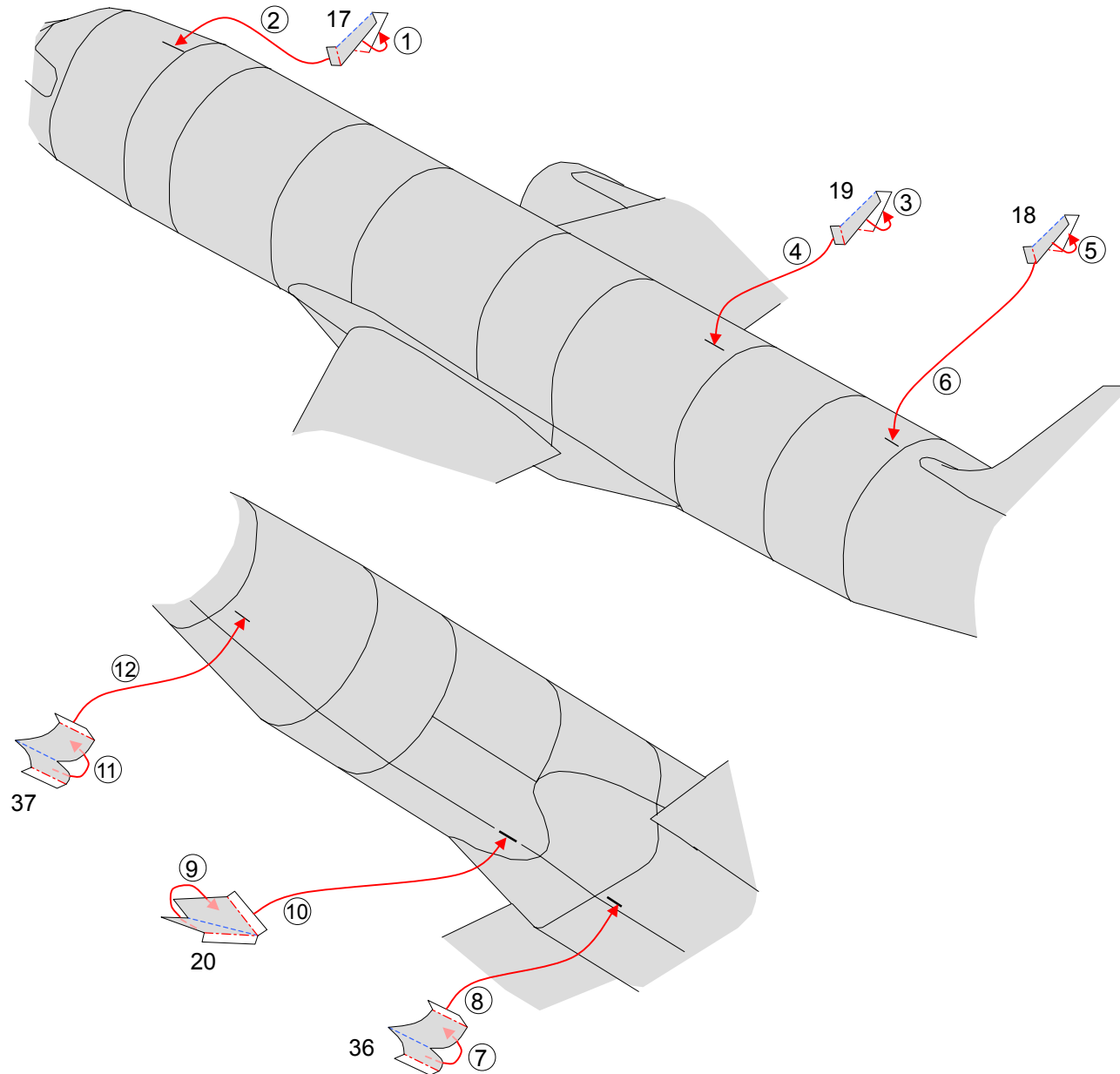



STARFLYER

STARFLYER AIRBUS A320 : ASSEMBLY INSTRUCTIONS



Canon® is a registered trademark of Canon Inc.
© Canon Inc. © P. Model K. Kiyonaga

27. Carry out this step if making a grounded model

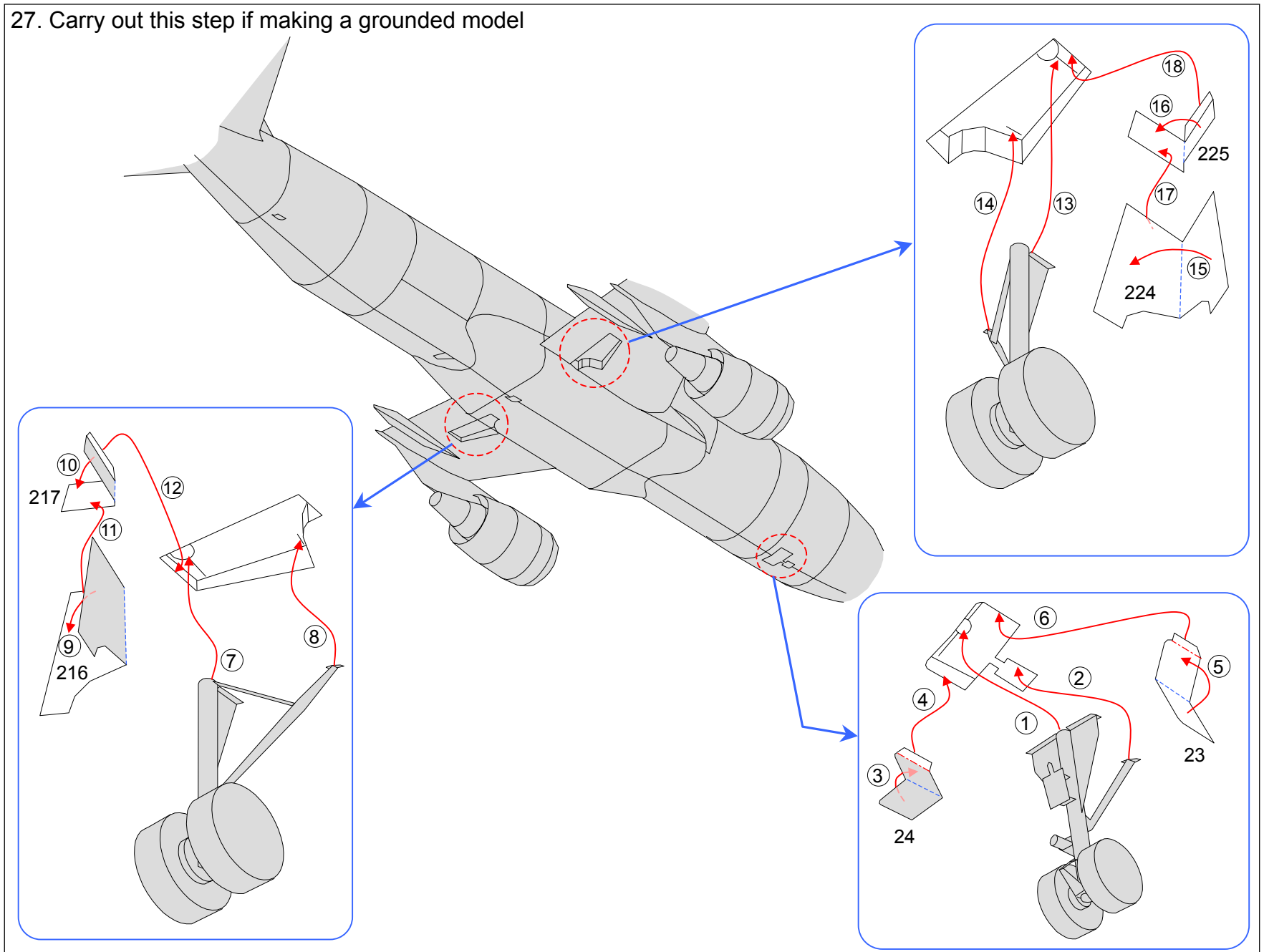



STARFLYER

STARFLYER AIRBUS A320 : ASSEMBLY INSTRUCTIONS



Canon® is a registered trademark of Canon Inc.
© Canon Inc. © P. Model K. Kiyonaga

28.

